

USER MANUAL

Pro Lite

Touch Panel PC

ENGLISH

Pro Lite TW2424A5

Thank you very much for choosing the iiyama Touch Panel PC. We recommend that you take a few minutes to read this comprehensive manual carefully before installing and switching on the Touch Panel PC. Please keep this manual in a safe place for your future reference.



Scan the QR code to find out additional software/services available for your Iiyama product or go to iiyama.com/signup



Dear user, we congratulate you on the purchase of your iiyama LCD.

For details on warranty and locally used pixel policies that apply directly after installation of your product please check the iiyama website.

To report a fault, please contact your local support centre found at <https://iiyama.com>

Things to check before you call the iiyama information line

- | if the power cable is connected securely and turned on?
- | if the display has been turned on?
- | if the signal cable is connected securely and the correct input selected?
- | if the computer has been restarted with the display connected?
- | if the graphics card is correctly installed with the latest drivers possible?
- | if the correct native resolution has been selected via 'Display Properties'?
- | If the R/G/B signal configuration is correct?
- | if the displays On Screen Menu is shown?
- | if the correct brightness and contrast settings have been set?
- | if given display tolerances and compatibility have been considered?
- | if via the On Screen Menu you have performed a Factory Reset/Recall?

Before reporting the screen defect, please prepare the following information/evidence:

- | model number *
- | purchase receipt and serial number *
- | name and address for collection
- | telephone/fax number, for availability during the day
- | convenient collection date (date, time)
- | short description of the defect

Important Note:

If there is no fault found in the collected equipment after inspection, the transferring party shall incur charges for transport and administration.

If you have checked all of the above and there is still no picture, call our information line for assistance in your country.

Feedback on health and safety issues

If you have any health and safety concerns or questions about the product (including when using the product), please contact iiyama support through our website. You can also contact us by calling +31 204460404. After receiving your feedback, we will ask the responsible unit to handle it as soon as possible and a dedicated person will get back to you. Your feedback will also be recorded and incorporated into our evaluation for improvements

* see the identification plate on the back of the case.

CE MARKING DECLARATION OF CONFORMITY

This Touch Panel PC complies with the requirements of the EC/EU Directive 2014/53/EU "Radio Equipment Directive", 2009/125/EC "ErP Directive" and 2011/65/EU "RoHS Directive".

The electro-magnetic susceptibility has been chosen at a level that gives correct operation in residential areas, business and light industrial premises and small-scale enterprises, inside as well as outside of the buildings. All places of operation are characterised by their connection to the public low voltage power supply system.

Radiation Exposure Statement:

This equipment complies with CE radiation exposure limits set forth for an uncontrolled environment. This equipment should be installed and operated with minimum distance 20cm between the radiator & body.

Operating Frequency range and the maximum output power (EIRP) are listed below:

ProLite TW2424AS-B1 / W1

Function	Frequency	Maximum Output Power (EIRP)
WiFi	2412-2472 MHz	15.98 dBm
	5180-5210 MHz	10.76 dBm
	5745-5825 MHz	11.15 dBm
Bluetooth BLE	2402-2480 MHz	7.23 dBm
Bluetooth BR+EDR	2402-2480 MHz	7.73 dBm

ProLite TW2424AS-B1 A / W1 A

Function	Frequency	Maximum Output Power (EIRP)
WiFi	2412-2472 MHz	16.86 dBm
	5180-5210 MHz	16.69 dBm
	5745-5825 MHz	12.58 dBm
Bluetooth BLE	2402-2480 MHz	7.85 dBm
Bluetooth BR+EDR	2402-2480 MHz	8.90 dBm

IYAMA CORPORATION: Wijkmeesterstraat 8, 2131 HA Hoofddorp, The Netherlands
Model No. : TW2424A



We recommend recycling of used product. Please contact your dealer or iiyama service center. Recycle information is obtained via the Internet, using the address: <https://iiyama.com>

You can access the Web page of different countries from there.

- We reserve the right to change specifications without notice.
- All trademarks used in this user manual are the property of their respective owners.

 **WARNING**



THIS PRODUCT CONTAINS A LITHIUM BUTTON BATTERY

Do not heat battery.

Do not deform battery.

Do not recharge battery.

Do not dispose of battery in fire.

Keep battery out of reach of children.

Keep battery away from direct sunlight and heat sources, do not storage in high temperature and humidity environment.

Swallowing battery can lead to chemical burns, perforation of soft tissue, and death. Severe burns can occur within 2 hours of ingestion. Seek medical attention immediately.

ENGLISH

Battery Model	CR2032
Battery Voltage/Typical Capacity	3V, 240mAh
Battery Manufacturer	Fujian Nanping Nanfu New Energy Co., Ltd 109 Industry Road, Nanping, Fujian, P.R.China P.C. 353000
Tel	(0086)-599-873-3158
Battery Europe Representative	Apex CE Specialists GmbH Grafenberger Allee 277, 40237 Düsseldorf, Germany
Contact Person	Wells, Yan
Email	Info@apex-ee.de



Please familiarize yourself with the local regulations regarding the separate collection of electrical and electronic products. It is important to follow these guidelines and avoid disposing of old products with regular household waste. Proper disposal helps prevent potential negative impacts on the environment and human health.

This product contains batteries that are subject to the European Regulation (EU) 2023/1542, which prohibits disposal with regular household waste. For more information, please visit our recycling page at https://iiyama.com/gl_en/support/#recycling

TABLE OF CONTENTS

FOR YOUR SAFETY.....	1
SAFETY PRECAUTIONS.....	1
SPECIAL NOTES ON LCD SCREEN	3
CUSTOMER SERVICE	4
CLEANING.....	4
SPECIAL NOTES ON TOUCH PANEL.....	4
BEFORE YOU OPERATE THE TOUCH PANEL PC.....	5
FEATURES.....	5
CHECKING THE CONTENTS OF THE PACKAGE	5
INSTALLATION	7
CONTROLS AND CONNECTORS.....	9
CONNECTING YOUR TOUCH PANEL PC.....	10
FITTING AND REMOVAL OF CABLE COVER	11
OPERATING THE TOUCH PANEL PC	12
TROUBLE SHOOTING	14
RECYCLING INFORMATION.....	14
SPECIFICATIONS :	
ProLite TW2424AS-B1 / ProLite TW2424AS-W1.....	15
SPECIFICATIONS :	
ProLite TW2424AS-B1 A / ProLite TW2424AS-W1 A.....	16
DIMENSIONS.....	17

FOR YOUR SAFETY

SAFETY PRECAUTIONS

WARNING

STOP OPERATING THE TOUCH PANEL PC WHEN YOU SENSE TROUBLE

If you notice any abnormal phenomena such as smoke, strange sounds or fumes, unplug the Touch Panel PC and contact your dealer or iiyama service center immediately. Further use may be dangerous and can cause fire or electric shock.

NEVER REMOVE THE CABINET

High voltage circuits are inside the Touch Panel PC. Removing the cabinet may expose you to the danger of fire or electric shock.

DO NOT PUT ANY OBJECT INTO THE TOUCH PANEL PC

Do not put any solid objects or liquids such as water into the Touch Panel PC. In case of an accident, unplug your Touch Panel PC immediately and contact your dealer or iiyama service center. Using the Touch Panel PC with any object inside may cause fire, electric shock or damage.

INSTALL THE TOUCH PANEL PC ON A FLAT, STABLE SURFACE

The Touch Panel PC may cause an injury if it falls or is dropped.

DO NOT USE THE TOUCH PANEL PC NEAR WATER

Do not use where water may be splashed or spilt onto the Touch Panel PC as it may cause fire or electric shock.

OPERATE UNDER THE SPECIFIED POWER SUPPLY

Be sure to operate the Touch Panel PC only with the specified power supply. Use of an incorrect voltage will cause malfunction and may cause fire or electric shock.

CORRECT USE OF THE AC ADAPTER

Use only the AC Adapter provided by iiyama. Any deviation from this by using another type of adapter may result in damage to the accessory and the Touch Panel PC by fire or electric shock.

DO NOT DISASSEMBLE THE AC ADAPTER

Disassembling the AC Adapter may expose you to the danger of fire or electric shock.

PROTECT THE CABLES

Do not pull or bend the AC adapter, the power cable and signal cable. Do not place the Touch Panel PC or any other heavy objects on the cables. If damaged, the cables may cause fire or electric shock.

ADVERSE WEATHER CONDITIONS

It is advisable not to operate the Touch Panel PC during a heavy thunder storm as the continual breaks in power may cause malfunction. It is also advised not to touch the plug in these circumstances as it may cause electric shock.

CAUTION

INSTALLATION LOCATION

Do not install the Touch Panel PC where sudden temperature changes may occur, or in humid, dusty or smoky areas as it may cause fire, electric shock or damage. It also shall not be exposed to excessive heat such as sunshine, fire or the like.

DO NOT PLACE THE TOUCH PANEL PC IN A HAZARDOUS POSITION

The Touch Panel PC may topple and cause injury if not suitably located. Please also ensure that you do not place any heavy objects on the Touch Panel PC, and that all cables are routed such that children may not pull the cables and possibly cause injury.

DISCONNECT THE CABLES WHEN YOU MOVE THE TOUCH PANEL PC

When you move the Touch Panel PC, turn off the power switch, unplug the Touch Panel PC and be sure the signal cable is disconnected. If you do not disconnect them, it may cause fire or electric shock.

UNPLUG THE TOUCH PANEL PC

If the Touch Panel PC is not in use for a long period of time it is recommended that it is left unplugged to avoid accidents.

HOLD THE PLUG WHEN DISCONNECTING

To disconnect the AC adapter, the power cable or signal cable, always pull it by the plug. Never pull on the cable itself as this may cause fire or electric shock.

DO NOT TOUCH THE PLUG WITH WET HANDS

Pulling or inserting the plug with wet hands may cause electric shock.

CAUTIONARY NOTICE ABOUT BATTERY

Battery can not be replaceable. If you need to replace the battery, contact your dealer or iiyama service center for safety concern.

OTHERS

ERGONOMIC RECOMMENDATIONS

To eliminate eye fatigue, do not operate the Touch Panel PC against a bright background or in a dark room. For optimal viewing comfort, the Touch Panel PC should be just below eye level and 40-60 cm (16-24 inches) away from your eyes. When using the Touch Panel PC over a prolonged time, a ten minute break every hour is recommended as looking at the screen continuously can cause eye strain.

SPECIAL NOTES ON LCD SCREEN

The following symptoms are normal with LCD screen and do not indicate a problem.

NOTE

- You may find slightly uneven brightness on the screen depending on the desktop pattern you use.
- Due to the nature of the LCD screen, an afterimage of the previous screen may remain after switching the image, when the same image is displayed for hours. In this case, the screen is recovered slowly by changing the image or turning off the Power Switch for some hours.

USAGE

This product can be used 24 hours a day with limited lifetime. If you use this product with reduced brightness to 50% of the maximum value, the lifetime of the LED backlight is typically 30,000 hours. This product supports Landscape, Portrait and Face-Up (Tabletop) orientations.

GHOSTING (GHOST IMAGE)

Please be aware that on all LCD screens you can experience ghosting. The ghost image occurs when a residual image remains visible on a screen when static images are displayed for a long period of time. The ghost image is not permanent, but still images being displayed for a long period of time should be avoided.

TO PREVENT GHOSTING (GHOST IMAGE)

To prevent ghosting and promote a longer life expectancy of the Touch Panel PC, we recommend the following:

- Use a screensaver that has moving graphics or blank and white images.
- Switch desktop backgrounds regularly.
- Lower the brightness of the Touch Panel PC.
- Turn off the Touch Panel PC when not in use or manage the power-off time by utilizing the multifunction clock.
- When the Touch Panel PC is installed in high ambient temperature environment(s) or is completely enclosed, we strongly recommend using an active ventilating system or cooling fans.

TO ELIMINATE GHOSTING (GHOST IMAGE)

- Turn off the Touch Panel PC for an extended period of time. It can be several hours or several days.
- Use a screen saver (black and/or white) and run it for an extended period of time.

CUSTOMER SERVICE

NOTE

- If you have to return your unit for service and the original packaging has been discarded, please contact your dealer or iiyama service center for advice or replacement packaging.

CLEANING

WARNING

- If you drop any materials or liquids such as water into the Touch Panel PC when cleaning, unplug the power cable immediately and contact your dealer or iiyama service center.

NOTE

- To protect the Touch screen surface, do not scratch or rub the screen with a hard object.
- Never use any of the following strong solvents. These will damage the cabinet and the Touch screen surface.

Thinner	Benzine	Abrasive cleaner
Spray-type cleaner	Wax	Acid or Alkaline solvent
- Touching the cabinet with any product made from rubber or plastic for a long time may cause degeneration or loss of paint on the cabinet.

CABINET

Stains can be removed with a cloth lightly moistened with a mild detergent solvent. Then wipe the cabinet with a soft dry cloth.

TOUCH SCREEN

Touch screen surface may be cleaned using a soft clean cloth moistened with mild window glass commercial cleaners or 50/50 mixture of water and IPA (ISO-propyl-alcohol). Don't use acid or alkaline solvent to clean the surface of the panel (or screen).

SPECIAL NOTES ON TOUCH PANEL

CAUTION

- Permanent damage can occur if Sharp Edged, Pointed or Metal items are used to activate Touch.
This could invalidate any remaining warranty.
We recommend you use a conductive stylus (tip R0.8 or over) or finger.

BEFORE YOU OPERATE THE TOUCH PANEL PC

FEATURES

- ◆ Supports Resolutions up to 1920 × 1080
- ◆ High Contrast 1000:1 (Typical) / Brightness 250cd/m² (Typical): ProLite TW2424AS-B1 / W1
- ◆ High Contrast 1000:1 (Typical) / Brightness 350cd/m² (Typical): ProLite TW2424AS-B1 A / W1 A
- ◆ Auto-Rotation
- ◆ 2 × 5W Stereo Speakers
- ◆ Android OS
- ◆ VESA Mounting Standard (100mm×100mm) Compliant

CHECKING THE CONTENTS OF THE PACKAGE

The following accessories are included in your package. Check to see if they are enclosed with the Touch Panel PC. If anything is missing or damaged, please contact your local iiyama dealer or regional iiyama office.

- AC Adapter *1
- Power Cable (Type: EU/UK) *2
- Cable Cover
- Screws for Cable Cover (2pcs)
- M4 Screws for VESA Mount (5pcs)
- Safety Guide
- Quick Start Guide

CAUTION

*1 Applicable AC Adapter

Type Name	FJ-SW20171205000
Manufacturer	SHENZHEN FUJIA APPLIANCE CO., LTD. 5F of Building F, Hengchangrong(xinghui) Sci-Tech. Park, Huaning Road, Longhua District, Shenzhen, Guangdong, P. R. China
Input Voltage	100-240VAC
Input AC Frequency	50/60Hz
Output Voltage	12.0VDC
Output Current	5.0A
Output Power	60.0W
Average Active Efficiency	88.32% minimum
Efficiency at Low Load (10%)	88.06% minimum
No-Load Power Consumption	0.20W maximum

*2 All guarantees and warranties are void for any problems or damage caused by a power cable not supplied by iiyama.

An approved power cable greater or equal to H05VVF, 3G, 0.75mm² must be used.

INSTALLATION

CAUTION Before installation, please make sure the wall or desktop arm is strong enough to hold the necessary weight of the Touch Panel PC and the mount.

[WALL MOUNTING]

CAUTION When using the wall mounting, consideration of thickness of the mounting stage needs to be taken. Tighten the M4 Screws (4pcs) which “L” length is 4mm to fasten the Touch Panel PC. Using a screw longer than this may cause electric shock or damage because it may contact with the electrical parts inside the Touch Panel PC.

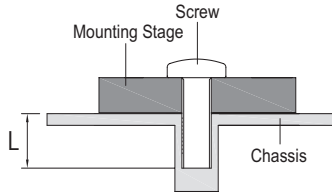

[BUILT-IN EQUIPMENT]

CAUTION This product is not designed for the purpose of being used in high temperature environment.
If the product is placed in an external cabinet, you need to design cooling fans and vents to keep the temperature low enough to fit in the product temperature specification.

[ROTATING THE TOUCH PANEL PC]

This Touch Panel PC is designed to be compatible in landscape, portrait and face-up modes.

ENGLISH

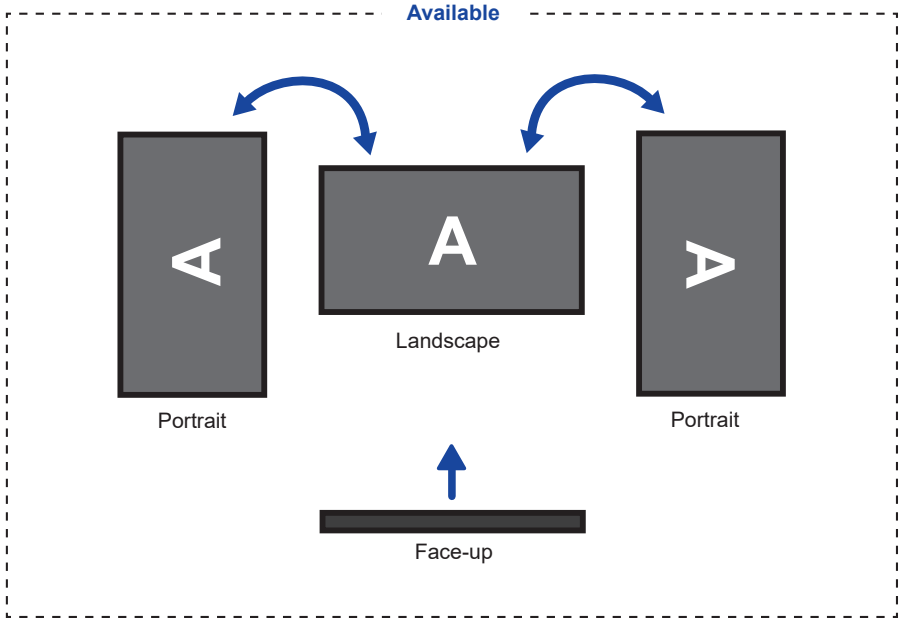

CONTROLS AND CONNECTORS

<Front>



<Back and Bottom>

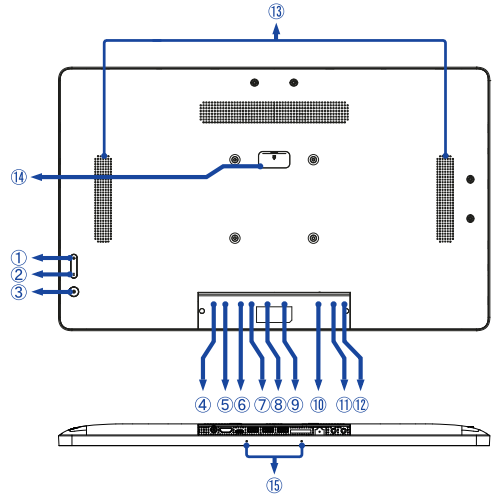

ENGLISH

- ① Volume + Button (+)
- ② Volume – Button (–)
- ③ Power Switch (⏻)

Hot Key

Sleep mode: Press the power or touch the screen for wake-up.

Shut-down: Keep pressing for 1 seconds to prompt restart and shut-down options.

Screenshot: Press ⏻ and – at the same time.

- ④ Connector for AC Adapter (≡ : Direct current) (DC)
- ⑤ HDMI Connector (HDMI IN)
- ⑥ USB Type-C Connector (DC5V, 900mA, video output only) (USB C)

NOTE

The computer connected to this port can access to the Micro SD Card / internal or external storage of the Touch Panel PC.

- ⑦ USB Connector (USB3.2 Gen 1: 5Gbps, 5V, 900mA) (USB 3.2)
- ⑧ USB Connector (USB 2.0: DC5V, 500mA) (USB 2.0)
- ⑨ USB Connector (USB 2.0: DC5V, 500mA) (USB 2.0)
- ⑩ RJ45 Connector (LAN)
- ⑪ Headphone Audio Jack (🎧)
- ⑫ Microphone Audio Jack (🎤)
- ⑬ Speakers
- ⑭ Not available for this model
- ⑮ Microphone

CONNECTING YOUR TOUCH PANEL PC

- ① Connect the AC Adapter to the Touch Panel PC first and then connect to the power source.
- ② Turn on your Touch Panel PC.

NOTE

- Make sure that the building installation has a circuit breaker of 120/240V, 20A (maximum).
- The Class I pluggable equipment Type A must be connected to protective earth.
- The socket-outlet shall be installed near the equipment and shall be easily accessible.
- Excessive sound pressure from ear-/headphones can cause hearing damage/hearing loss.
- The initial setup of the operating system takes approximately 5-10 minutes.
- To setup the Android OS for the Touch Panel PC, turn on the Touch Panel PC and follow the instructions on the screen.

[Example of Connection]

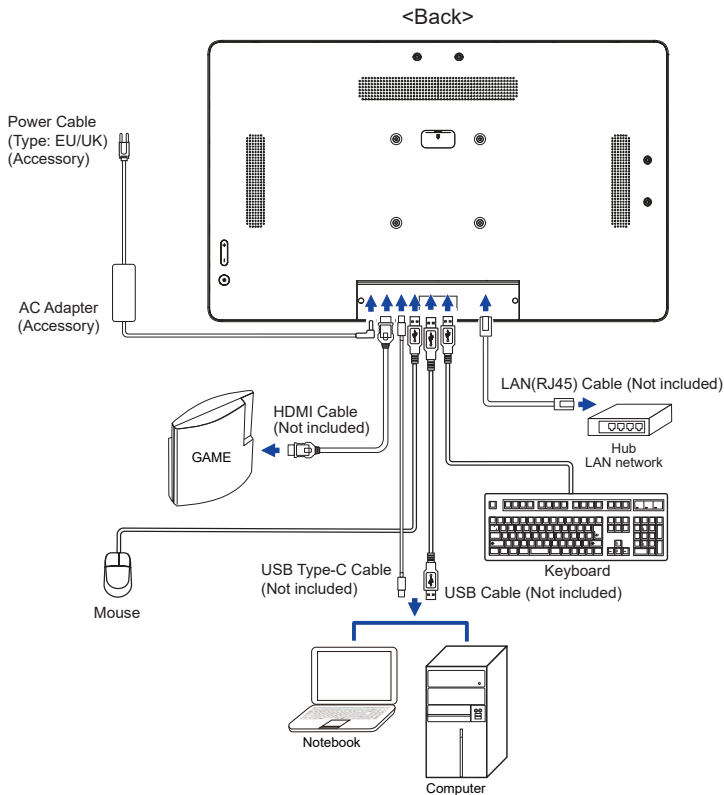

FITTING AND REMOVAL OF CABLE COVER

Put a piece of soft cloth on the table beforehand to prevent the Touch Panel PC from being scratched.
Lay the Touch Panel PC flat on a table with front face down.

[Fitting]

- ① Put the connected cables through the holes of the cable cover.
- ② Fix the cable cover firmly with the screws.

[Removal]

Unscrew to remove the cable cover.

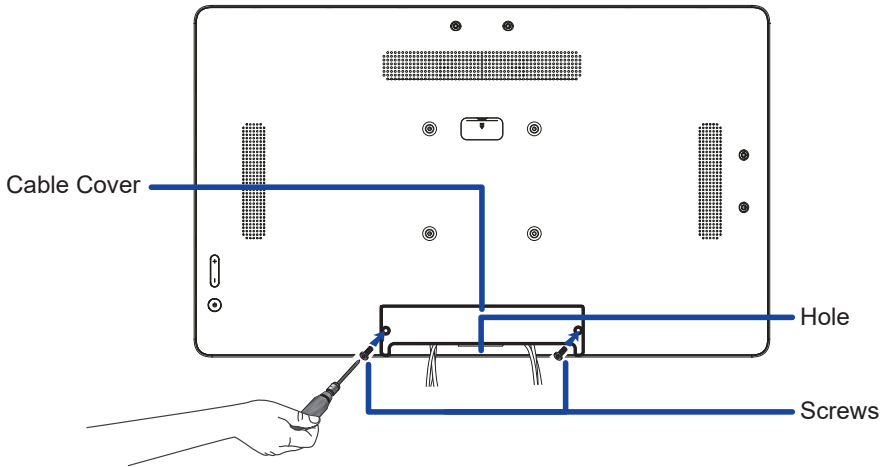





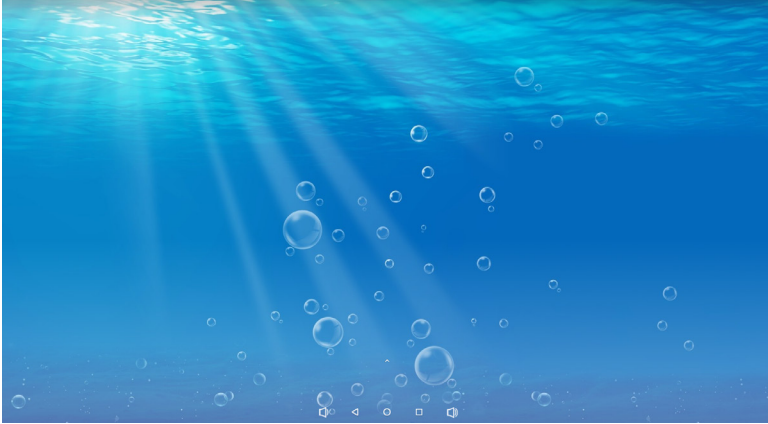

OPERATING THE TOUCH PANEL PC

The home screen is displayed when the Touch Panel PC is turned on.



<System bar icons>

-  : Volume down
-  : Return to exit and the previous page.
-  : Return to the home screen.
-  : Show a list of recently run applications.
-  : Volume up

-  : Display all apps.

KIOSK mode operating steps



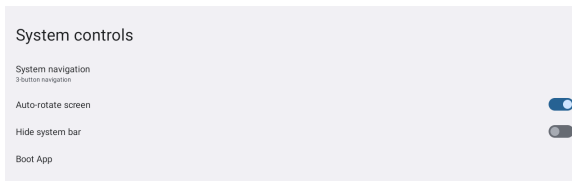



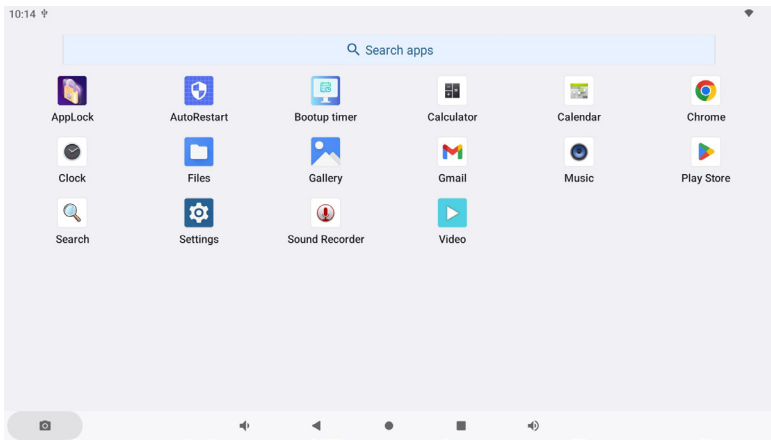









① Go to Settings -> Accessibility -> System Controls



- ② Choose in the Boot app menu which app needs to be opened in Kiosk mode after screen starts up.
- ③ Enable Hide System bar function, so end user will not be able to exit from an app. (Unless an app itself has Exit feature).
- ④ In System navigation menu choose 3-button navigation.
- ⑤ After a reboot the screen will open an app automatically.
- ⑥ To enable the System bar press the power button on the back of the screen two times. In this case Hide System bar setting will be disabled.



<Applications>

- *  : Lock application by entering 4 digits password.
-  : Manage restart time.
-  : Manage power-on/off time.
-  : Calculator
-  : Calendar
-  : Chrome
-  : Alarm / Clock / Timer / Stopwatch
-  : Manage files and folders on the device.
-  : Organize albums.
-  : Gmail
-  : Play audio files.
-  : Play store.
-  : Search engine.
-  : System preferences
-  : Sound recorder
-  : Play video files.

NOTE * USB Slave Lock: Disables access to the Micro SD card / internal or external storage of the Touch Panel PC via the USB Slave port.

Key Lock: Disables Power Switch, Volume + and Volume – Buttons.

TROUBLE SHOOTING

If the Touch Panel PC fails to operate correctly, please follow the steps below for a possible solution.

1. Perform the adjustments described in OPERATING THE TOUCH PANEL PC, depending on the problem you have. If the Touch Panel PC does not get a picture, skip to 2.
2. Consult the following items if you cannot find an appropriate adjustment item in OPERATING THE TOUCH PANEL PC or if the problem persists.
3. If you are experiencing a problem which is not described below or you cannot correct the problem, discontinue using the Touch Panel PC and contact your dealer or iiyama service center for further assistance.

Problem	Check
① The picture does not appear.	<input type="checkbox"/> The AC Adapter and Power Cable are firmly seated in the connector and the socket. <input type="checkbox"/> The Power Switch is turned ON. <input type="checkbox"/> The AC socket is live. Please check with another piece of equipment. <input type="checkbox"/> If the Touch Panel PC is in sleep mode, press the Power Switch or any other button or touch the screen. <div style="margin-left: 20px; padding-top: 5px;"> NOTE ■ By default, the Touch Panel PC enters into sleep mode after 10 minutes of no operation. You can choose "Never" in the application of Settings / Display / Sreen timeout. </div> <input type="checkbox"/> Increase the Brightness. <input type="checkbox"/> The pins of the connectors are not crooked or broken.
② The screen is shaking.	<input type="checkbox"/> The power voltage is within the specification of the Touch Panel PC.
③ No sound	<input type="checkbox"/> The Volume is turned up. <input type="checkbox"/> Check the sound settings.
④ The touch screen does not work.	<input type="checkbox"/> It takes about 15 seconds or more to activate the P-CAP touch screen function after power is turned off and on. This is normal operation. Please wait for a certain period.

RECYCLING INFORMATION

For better environment protection please don't dispose your Touch Panel PC.
 Please visit our web site: <https://iiyama.com> for Touch Panel PC recycling.

SPECIFICATIONS : ProLite TW2424AS-B1 / ProLite TW2424AS-W1

Touch Screen	Technology	In-cell 10pt touch	
	Hardness	3H	
Size Category		23.8"	
Panel	Panel technology	IPS (ADS)	
	Size	Diagonal: 60.5cm (23.8")	
	Pixel pitch	0.275mm H × 0.275mm V	
	Brightness	250cd/m ² (Typical)	
	Contrast ratio	1000 : 1 (Typical: with Touch panel)	
	Viewable angle	Horizontal : 178 degrees, Vertical: 178 degrees (Typical)	
	Response time	>14ms (Gray to Gray)	
Surface Treatment		Anti-Glare, Haze 25%, Hard Coating(3H)	
Display Colors		Approx. 16.7M	
Maximum Resolution		1920 × 1080, 2 MegaPixel	
CPU		Rockchip RK3399 up to 1.8GHz	
GPU		Dual-core A72 + Quad-core A53	
Storage		32GB eMMC	
Memory		4GB LPDDR4	
Wi-Fi	LAN	IEEE802.11a/b/g/n/ac	100M/1000M
Bluetooth		5.2	
Microphone		Dual Microphone	
External IO Port *1		LAN (RJ45) × 1, USB3.2 Gen 1 (5Gbps, DC5V, 900mA) × 1, USB2.0 (DC5V, 500mA) × 2, HDMI (input, 1920×1080 60Hz) × 1, USB C (DC5V, 900mA, video output only, touch board function) × 1, Headphone (ø3.5mm mini jack) × 1, Microphone (ø3.5mm mini jack) × 1	
OS version		Android 12	
Speakers		5W × 2 (Stereo speakers)	
Maximum Screen Size		527.0mm W × 296.5mm H / 20.7" W × 10.6" H	
Power Source		12VDC, 5.0A	
Power Consumption *2		19W typical	
Dimensions / Net Weight		549.5 × 336.0 × 28.0mm / 21.6 × 13.2 × 1.1" (W×H×D) 4.23kg / 9.3 lbs (Excluding the AC Adapter)	
Environmental Considerations		Operating: Temperature 0 to 40°C / 32 to 104°F Humidity 10 to 80% (No condensation) Storage: Temperature -20 to 60°C / 14 to 140°F Humidity 10 to 90% (No condensation)	
Approvals		CE, UKCA, EAC	

NOTE *1 USB C support only mirroring mode in video output, touch mode only support Win 10 and 11 Operating System.

*2 When the USB devices are not connected.

SPECIFICATIONS : ProLite TW2424AS-B1 A / ProLite TW2424AS-W1 A

ENGLISH

Touch Screen	Technology	In-cell 10pt touch	
	Hardness	3H	
Size Category		23.8"	
Panel	Panel technology	IPS (ADS)	
	Size	Diagonal: 60.5cm (23.8")	
	Pixel pitch	0.275mm H × 0.275mm V	
	Brightness	350cd/m ² (Typical)	
	Contrast ratio	1000 : 1 (Typical: with Touch panel)	
	Viewable angle	Horizontal : 178 degrees, Vertical: 178 degrees (Typical)	
	Response time	>9ms (Gray to Gray)	
Surface Treatment		Anti-Glare, Haze 25%, Hard Coating(3H)	
Display Colors		Approx. 16.7M	
Maximum Resolution		1920 × 1080, 2 MegaPixel	
CPU		Rockchip RK3399 up to 1.8GHz	
GPU		Dual-core A72 + Quad-core A53	
Storage		32GB eMMC	
Memory		4GB LPDDR4	
Wi-Fi	LAN	IEEE802.11a/b/g/n/ac	100M/1000M
Bluetooth		5.2	
Microphone		Dual Microphone	
External IO Port *1		LAN (RJ45) × 1, USB3.2 Gen 1 (5Gbps, DC5V, 900mA) × 1, USB2.0 (DC5V, 500mA) × 2, HDMI (input, 1920×1080 60Hz) × 1, USB C (DC5V, 900mA, video output only, touch board function) × 1, Headphone (ø3.5mm mini jack) × 1, Microphone (ø3.5mm mini jack) × 1	
OS version		Android 12	
Speakers		5W × 2 (Stereo speakers)	
Maximum Screen Size		527.0mm W × 296.5mm H / 20.7" W × 10.6" H	
Power Source		12VDC, 5.0A	
Power Consumption *2		19W typical	
Dimensions / Net Weight		549.5 × 336.0 × 28.0mm / 21.6 × 13.2 × 1.1" (W×H×D) 4.23kg / 9.3 lbs (Excluding the AC Adapter)	
Environmental Considerations		Operating: Temperature 0 to 40°C / 32 to 104°F Humidity 10 to 80% (No condensation) Storage: Temperature -20 to 60°C / 14 to 140°F Humidity 10 to 90% (No condensation)	
Approvals		CE, UKCA, EAC	

NOTE *1 USB C support only mirroring mode in video output, touch mode only support Win 10 and 11 Operating System.

*2 When the USB devices are not connected.

DIMENSIONS

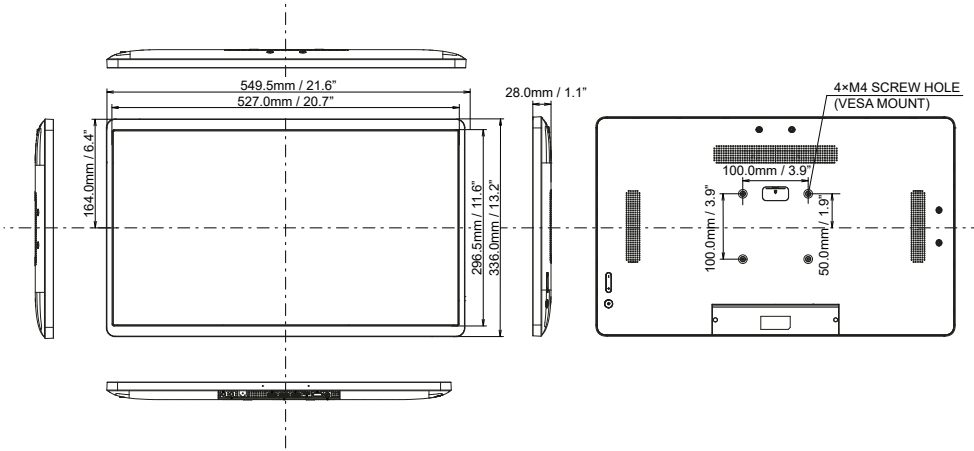

ENGLISH