

# USER MANUAL

# *ProLite*

## LCD Monitor

ENGLISH

### *ProLite TE9804MIS*

Thank you very much for choosing the iiyama LCD monitor.

We recommend that you take a few minutes to read this comprehensive manual carefully before installing and switching on the monitor. Please keep this manual in a safe place for your future reference.



## Dear user, we congratulate you on the purchase of your iiyama LCD.

For details on warranty and locally used pixel policies that apply directly after installation of your product please check the iiyama website.

## To report a fault, please contact your local support centre found at [www.iiyama.com/service](http://www.iiyama.com/service)

### Things to check before you call the iiyama information line

- | if the power cable is connected securely and turned on?
- | if the display has been turned on?
- | if the signal cable is connected securely and the correct input selected?
- | if the computer has been restarted with the display connected?
- | if the graphics card is correctly installed with the latest drivers possible?
- | if the correct native resolution has been selected via 'Display Properties'?
- | If the R/G/B signal configuration is correct?
- | if the displays On Screen Menu is shown?
- | if the correct brightness and contrast settings have been set?
- | if given display tolerances and compatibility have been considered?
- | if via the On Screen Menu you have performed a Factory Reset/Recall?

### Before reporting the screen defect, please prepare the following information/evidence:

- | model number \*
- | purchase receipt and serial number \*
- | name and address for collection
- | telephone/fax number, for availability during the day
- | convenient collection date (date, time)
- | short description of the defect

### Important Note:

If there is no fault found in the collected equipment after inspection, the transferring party shall incur charges for transport and administration.

If you have checked all of the above and there is still no picture, call our information line for assistance in your country.

\* see the identification plate on the back of the case.

## CE MARKING DECLARATION OF CONFORMITY

This LCD monitor complies with the requirements of the EC/EU Directive 2014/30/EU "EMC Directive", 2014/35/EU "Low Voltage Directive", 2009/125/EC "ErP Directive" and 2011/65/EU "RoHS Directive".

### Warning

This is a class A product. In a domestic environment this product may cause radio interference in which case the user may be required to take adequate measures.

IİYAMA CORPORATION: Wijkmeerstraat 8, 2131 HA Hoofddorp, The Netherlands

Model No. : PL9804U



We recommend recycling of used product. Please contact your dealer or iiyama service center. Recycle information is obtained via the Internet, using the address: <http://www.iiyama.com>

You can access the Web page of different countries from there.

- We reserve the right to change specifications without notice.
- All trademarks used in this user manual are the property of their respective owners.

# TABLE OF CONTENTS

FOR YOUR SAFETY.....	1
SAFETY PRECAUTIONS.....	1
SPECIAL NOTES ON LCD MONITORS.....	3
CUSTOMER SERVICE.....	5
CLEANING.....	5
BEFORE YOU OPERATE THE MONITOR.....	6
FEATURES.....	6
CHECKING THE CONTENTS OF THE PACKAGE.....	6
UNPACKING.....	7
SPECIAL NOTES ON THE TOUCH PANEL.....	7
INSTALLATION.....	8
CONTROLS AND CONNECTORS : MONITOR.....	10
CONTROLS : REMOTE CONTROL.....	12
PREPARING THE REMOTE CONTROL.....	13
BASIC OPERATION.....	15
CONNECTING YOUR MONITOR.....	18
COMPUTER SETTING.....	22
OPERATING THE MONITOR.....	24
ADJUSTMENT MENU CONTENTS.....	26
SCREEN ADJUSTMENTS.....	44
STANDBY FEATURE.....	47
TROUBLE SHOOTING.....	48
RECYCLING INFORMATION.....	49
APPENDIX.....	50
SPECIFICATIONS : ProLite TE9804MIS.....	50
DIMENSIONS.....	51
COMPLIANT TIMING.....	52

# FOR YOUR SAFETY

## SAFETY PRECAUTIONS

### WARNING

#### **STOP OPERATING THE MONITOR WHEN YOU SENSE TROUBLE**

If you notice any abnormal phenomena such as smoke, strange sounds or fumes, unplug the monitor and contact your dealer or iiyama service center immediately. Further use may be dangerous and can cause fire or electric shock.

#### **NEVER REMOVE THE CABINET**

High voltage circuits are inside the monitor. Removing the cabinet may expose you to the danger of fire or electric shock.

#### **DO NOT PUT ANY OBJECT INTO THE MONITOR**

Do not put any solid objects or liquids such as water into the monitor. In case of an accident, unplug your monitor immediately and contact your dealer or iiyama service center. Using the monitor with any object inside may cause fire, electric shock or damage.

#### **INSTALL THE MONITOR ON A FLAT, STABLE SURFACE**

The monitor may cause an injury if it falls or is dropped.

#### **DO NOT USE THE MONITOR NEAR WATER**

Do not use where water may be splashed or spilt onto the monitor as it may cause fire or electric shock.

#### **OPERATE UNDER THE SPECIFIED POWER SUPPLY**

Be sure to operate the monitor only with the specified power supply. Use of an incorrect voltage will cause malfunction and may cause fire or electric shock.

#### **PROTECT THE CABLES**

Do not pull or bend the power cable and signal cable. Do not place the monitor or any other heavy objects on the cables. If damaged, the cables may cause fire or electric shock.

#### **ADVERSE WEATHER CONDITIONS**

It is advisable not to operate the monitor during a heavy thunder storm as the continual breaks in power may cause malfunction. It is also advised not to touch the plug in these circumstances as it may cause electric shock.

## CAUTION

### INSTALLATION LOCATION

Do not install the monitor where sudden temperature changes may occur, or in humid, dusty or smoky areas as it may cause fire, electric shock or damage. You should also avoid areas where the sun shines directly on the monitor.

### DO NOT PLACE THE MONITOR IN A HAZARDOUS POSITION

The monitor may topple and cause injury if not suitably located. Please also ensure that you do not place any heavy objects on the monitor, and that all cables are routed such that children may not pull the cables and possibly cause injury.

### MAINTAIN GOOD VENTILATION

Ventilation slots are provided to keep the monitor from overheating. Covering the slots may cause fire. To allow adequate air circulation, place the monitor at least 10 cm (or 4 inches) from any walls. Operating the monitor on its back, side, upside down or on a carpet or any other soft material may also cause damage.

### DISCONNECT THE CABLES WHEN YOU MOVE THE MONITOR

When you move the monitor, turn off the power switch, unplug the monitor and be sure the signal cable is disconnected. If you do not disconnect them, it may cause fire or electric shock.

### UNPLUG THE MONITOR

If the monitor is not in use for a long period of time it is recommended that it is left unplugged to avoid accidents.

### HOLD THE PLUG WHEN DISCONNECTING

To disconnect the power cable or signal cable, always pull it by the plug. Never pull on the cable itself as this may cause fire or electric shock.

### DO NOT TOUCH THE PLUG WITH WET HANDS

Pulling or inserting the plug with wet hands may cause electric shock.

### WHEN YOU INSTALL THE MONITOR ON YOUR COMPUTER

Be sure the computer is strong enough to hold the weight of the monitor, otherwise, you may damage your computer.

## OTHERS

### ERGONOMIC RECOMMENDATIONS

To eliminate eye fatigue, do not operate the monitor against a bright background or in a dark room. For optimal viewing comfort, the monitor should be just below eye level and 40-60 cm (16-24 inches) away from your eyes. When using the monitor over a prolonged time, a ten minute break every hour is recommended as looking at the screen continuously can cause eye strain.

## SPECIAL NOTES ON LCD MONITORS

- The following symptoms are normal with LCD monitors and do not indicate a problem.

### NOTE

- When you first turn on the LCD monitor, the picture may not fit in the display area because of the type of computer that is used. In this case, adjust the picture position to the correct position.
  - You may find slightly uneven brightness on the screen depending on the desktop pattern you use.
  - Due to the nature of the LCD screen, an afterimage of the previous screen may remain after switching the image, when the same image is displayed for hours. In this case, the screen is recovered slowly by changing the image or turning off the Power Switch for hours.
- This LCD cannot be used outdoors.
  - This LCD cannot be used with the screen facing upwards.
  - If you use a cable longer than the supplied one, the picture quality is not guaranteed. Touch function can be disrupted if the USB cable length exceeds 3m.

## USAGE CONFIRMATION

This product is designed for optimum usage at 24 hours per day.

The display is compatible for usage in Landscape applications.

## IMAGE PERSISTENCE / IMAGE STICKING

Please be aware that all LCD screens can experience Image Persistence or Image Sticking. This occurs when a residual image remains visible on a screen when static images are displayed for long periods of time. LCD Image Persistence is not permanent but constant images being displayed for a long period of time should be avoided.

To counteract Image Persistence, turn off the monitor for as long as the previous image was displayed, so if an image was on the monitor for 1 hour and there is evidence of a residual or “ghost” image, you should turn off the monitor for 1 hour in order to clear the residual image.

For all LFD products, iiyama recommends displaying moving images and utilising a moving screen saver at regular intervals whenever the screen is idle. You could also turn off the monitor when not in use to assist the prevention.

Other ways to reduce the risk of Image Persistence will be to utilise the FAN-on function (if available), Low Backlight and Low Brightness settings.

## FOR EXTENDED USE AS A PUBLIC DISPLAY

### ■ Image Sticking on LCD Panel

When a static image is displayed for hours, an electric charge trace remains near the electrode inside the LCD producing a “ghost” image. (Image Persistence).

Image Persistence is not a permanent feature.

### ■ Recommendations

To prevent Image Sticking and promote longer life expectancy of display, we recommend the following:

1. Avoid static images displayed for long periods – change static images on continuous loop.
2. Turn off monitor when not in use, either by remote control or use Standby or Schedule functions.
3. Check the Monitor Menu Settings for "Pixel Shift" etc. and activate it when available. This will reduce the Image Sticking Effect.
4. When monitor is installed in high ambient temperature environment(s) or in an enclosed position, utilise the Cooling Fan, Screen Saver and Low Brightness functions.
5. Suitable ventilation for any monitor is an expectation of any installation – climate control systems may need to be employed.
6. We strongly recommend utilisation of active cooling with fans for long operation times or high ambient temperature environments.



## CUSTOMER SERVICE

### NOTE

- If you have to return your unit for service and the original packaging has been discarded, please contact your dealer or iiyama service center for advice or replacement packaging.

## CLEANING

### WARNING

- If you drop any materials or liquids such as water into the monitor when cleaning, unplug the power cable immediately and contact your dealer or iiyama service center.

### CAUTION

- For safety reasons, turn off the power switch and unplug the monitor before you clean it.

### NOTE

- To protect the LCD panel, do not scratch or rub the screen with a hard object.
- Never use any of the following strong solvents. These will damage the cabinet and the LCD screen.

Thinner	Benzine	Abrasive cleaner
Spray-type cleaner	Wax	Acid or Alkaline solvent

- Touching the cabinet with any product made from rubber or plastic for a long time may cause degeneration or loss of paint on the cabinet.

### CABINET

Stains can be removed with a cloth lightly moistened with a mild detergent solvent. Then wipe the cabinet with a soft dry cloth.

### LCD

Periodic cleaning with a soft dry cloth is recommended.

### SCREEN

Don't use tissue paper etc. because these will damage the LCD screen.

# BEFORE YOU OPERATE THE MONITOR

## FEATURES

- ◆ Supports Resolutions up to 3840 × 2160
- ◆ High Contrast 1200:1 (Typical: without glass) / Brightness 350cd/m<sup>2</sup> (Typical: without glass)
- ◆ Digital Character Smoothing
- ◆ Automatic Set-up
- ◆ USB Type-C / RJ45 Connectors
- ◆ USB Power Delivery supports up to 65W
- ◆ 2 × 16W (Typical) Stereo Speakers
- ◆ Standby Feature (VESA DPMS Compliant)
- ◆ VESA Mounting Standard (800mm×600mm) Compliant
- ◆ Glass with AG coating

## CHECKING THE CONTENTS OF THE PACKAGE

The following accessories are included in your package. Check to see if they are enclosed with the monitor. If anything is missing or damaged, please contact your local iiyama dealer or regional iiyama office.

- |   |                     |                               |
|---|---------------------|-------------------------------|
| ■ Power Cable*                            | ■ HDMI Cable        | ■ Touch USB Cable             |
| ■ Remote Control                          | ■ Battery (2pcs)    | ■ Touch Pen (Dual head: 4pcs) |
| ■ Cable ties (For cable management, 6pcs) |                     | ■ USB Sticker (6pcs)          |
| ■ Safety Guide                            | ■ Quick Start Guide |                               |

### CAUTION

\* The rating of the Power Cable enclosed in 120V area is 10A/125V. If you are using a power supply higher than this rating, then a power cable with a rating of 10A/250V must be used. However, all guarantees and warranties are void for any problems or damage caused by a power cable not supplied by iiyama.

An approved power cable greater or equal to H05VVVF, 3G, 0.75mm<sup>2</sup> must be used.

## UNPACKING

### CAUTION

Moving the monitor requires at least two people. If not, it may drop and could result in a serious injury.

## SPECIAL NOTES ON THE TOUCH PANEL

### CAUTION

Permanent damage can occur if Sharp Edged, Pointed or Metal items are used to activate Touch. This could invalidate any remaining warranty. We recommend you use a plastic stylus (tip  $\varnothing$ 3mm or over) or finger.

## INSTALLATION

### CAUTION

- Follow the manual instructions for the type of mount you have selected. Refer all servicing to qualified service personnel.
- Moving the monitor requires at least two people.
- Before installation, please make sure the wall is strong enough to hold the necessary weight of the display and the mount.

ENGLISH

### [WALL MOUNTING]

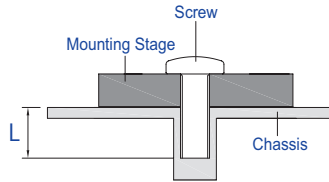

### CAUTION

When using the wall mounting, consideration of thickness of the mounting stage needs to be taken. Tighten the M8 Screws (4pcs) with washer which "L" length is 25mm to fasten the monitor. Using a screw longer than this may cause electric shock or damage because it may contact with the electrical parts inside the monitor.

**[INSTALLATION NOTE]**

The touch kit of this monitor is an optical device that utilizes infrared light source and sensitive sensors for touch detection.

Notice the incident light that contains large quantities of infrared light may affect touch screen operation and performance.

Please install it with care as follows to ensure reliable touch performance.

Intense light / Specular light / Focus spotlight / Wide spread light / Direct sunlight / Indirect sunlight from the window and/or the glass door. / Not install the touch monitor right under the light source.

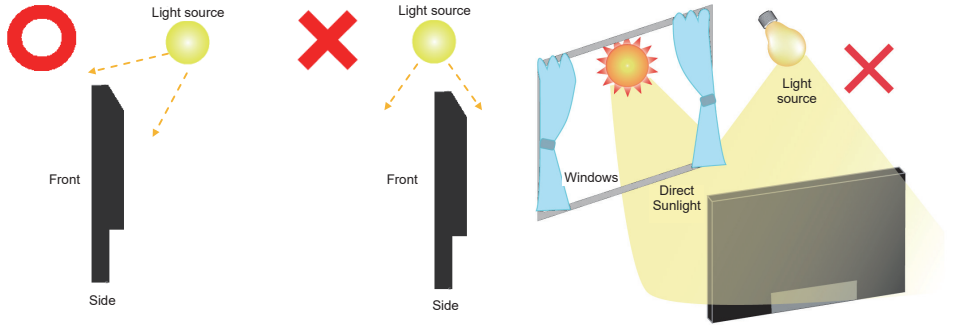

**[ROTATING THE DISPLAY]**

It is designed to be compatible in landscape mode.

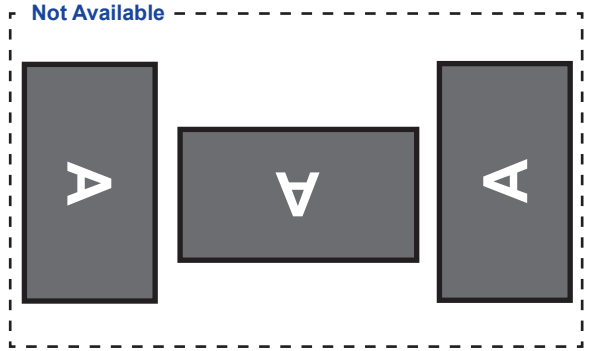
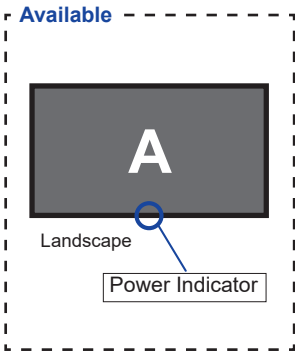

## CONTROLS AND CONNECTORS : MONITOR

<Front>

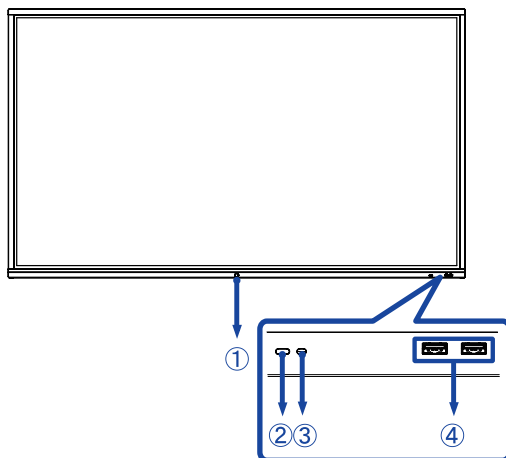

①	Power Button		<b>Power Off</b> Pressing and holding the Power Button on the front for 3-5 seconds.
	Power Indicator	Blue	Normal Operation
		Red	<b>Standby Mode</b> When the power indicator light is lighting red, the display is in Power Save Mode. To turn the screen back on, you can press the power button on the front or the remote control.
		Red & Blue flashing slow	The Screen Off function is active. To turn the screen back on, you can touch the screen or any button on the remote control.
	Red & Blue flashing fast	Going to the Standby Mode or system is updating.	
②	Remote Sensor		
③	Light Sensor		
④	USB Connector (3.0)		USB3.0 (5V, 900mA)

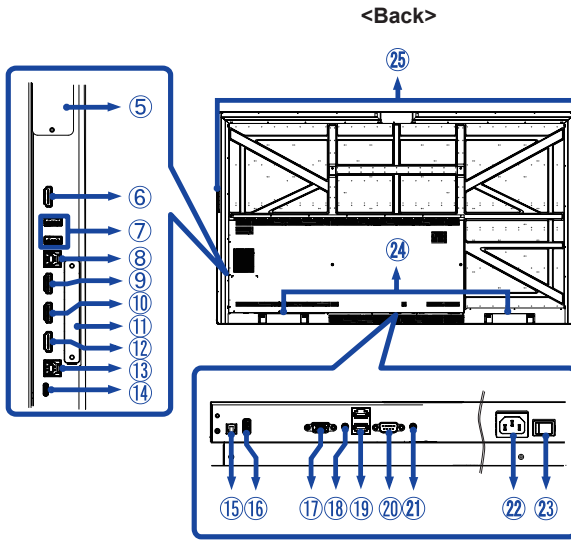

⑤	Option PC module slot	
⑥	HDMI Connector (HDMI OUT)	HDMI
⑦	USB Connector (3.0)	USB3.0 (5V, 900mA)
⑧	Touch USB Connector (TOUCH 1)	USB (for HDMI1/HDMI2)
⑨	HDMI Connector (HDMI IN 1)	HDMI
⑩	HDMI Connector (HDMI IN 2)	HDMI
⑪	Option WiFi/BT module slot	
⑫	HDMI Connector (HDMI IN 3)	HDMI
⑬	Touch USB Connector (TOUCH 2)	USB (for HDMI3/VGA)
⑭	USB-C Connector (USB-C3.1 PD 65W)	USB-C3.1 (5V, 3A / 9V, 3A / 12V, 3A / 20V, 3.25A)
⑮	SPDIF Connector (SPDIF)	SPDIF Output
⑯	USB Connector (2.0)	USB2.0 (for software update)
⑰	VGA Connector (VGA)	VGA
⑱	Audio Connector (AUDIO IN)	Mini Jack
⑲	LAN(RJ45) Connector (LAN)	RJ45 (In/Out auto switching)
⑳	RS232C Connector (RS232)	RS232C 9pin
㉑	Headphone Connector (AUDIO OUT)	Mini Jack
㉒	AC Connector ( ~ : Alternating current)	
㉓	Main Power Switch   (On) / ○ (Off)	
㉔	Speakers	
㉕	Handles	

## CONTROLS : REMOTE CONTROL

ENGLISH

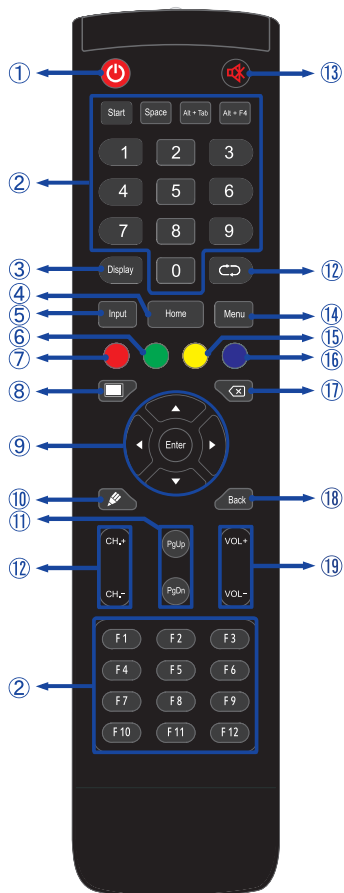

①		Turn the monitor ON and OFF.
②	Number (1-9) / Other / Function (F1-F12)	Under iiWare: 0-9 numeric input Under Windows: 0-9 numeric input, Start/Space/ALT+Tab/ALT+F4/F1-12 for Keyboard function
③	Display	Provide source and resolution information.
④	Home	Android system main screen button.
⑤	Input	Select the source.
⑥	Green	Lock and unlock Buttons function.
⑦	Red	Lock and unlock Buttons and Touch function.
⑧	Screen Off	Turn the backlight On and Off.
⑨		Navigate through submenus and settings. ▲: Up Button ▼: Down Button ◀: Left Button ▶: Right Button
	Enter	Confirm your selection or save changes.
⑩		Quickly start "Writing Software".
⑪	PgUp / PgDn	When select File: The first / Last When Internet browser: Scroll Up / Scroll Down
⑫		Not available on this model.
⑬		Turn on or off the mute function when the Menu is not displayed.
⑭	MENU	Display the "Screen Setting" menu when the Android system is not displayed.
⑮	Yellow	Lock and unlock Touch function.
⑯	Blue	Freeze the picture.
⑰		Backspace
⑱	Back	Return to a previous menu or closes the OSD Menu.
⑲	VOL+ / VOL-	VOL+: Increase the sound volume. VOL-: Decrease the sound volume.



## PREPARING THE REMOTE CONTROL

To use the remote control, insert the two dry batteries.

### CAUTION

- Do not use any other batteries other than those specified in this manual for the Remote Control.
- Do not insert old and new batteries together in the Remote Control.
- Make sure that the terminals match the "+" and "-" indications in the battery compartment.
- Remove the dead batteries immediately to prevent them from liquid leaking into the battery compartment.
- Burst batteries or the electrolyte from these batteries may cause stains, fire or injury.

- ① Open back cover of battery component on the back of remote control.

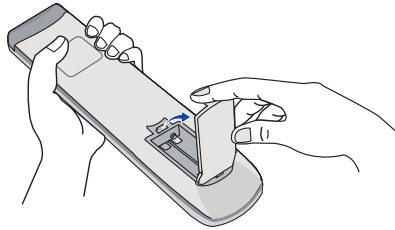

- ② Align and insert two AAA batteries according to their plus and minus ports (as indicated in the remote control).

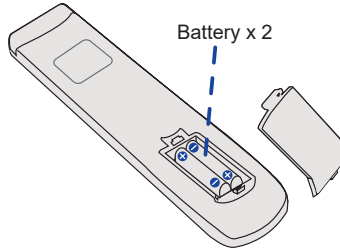

- ③ After battery is installed, close the back cover of battery components, and make the following clip buckled to the bottom.

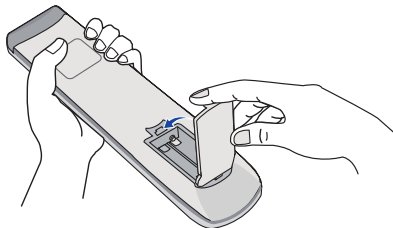

**NOTE**

- Refer to the above instructions when taking out the batteries.
- Replace with new batteries when the Remote Control does not work close to the monitor.  
Use AAA dry batteries. Risk of explosion if battery is replaced by an incorrect type.
- Operate the Remote Control by pointing it toward the Remote Sensor on the monitor.
- Other manufacturers remote control will not work with this monitor. Use the provided Remote Control ONLY.
- Used batteries needed to follow the city rule to be discarded. (suggestion: to dispose of used batteries please follow correct policy as per your council regulations)
- Batteries shall not be exposed to excessive heat such as sunshine, fire or the like.
- If you do not intend to use the remote control for a long period, remove the batteries.

## BASIC OPERATION

### ■ Turning the monitor ON

The monitor is turned On and the Power Indicator turns to Blue when you press the Power Button on the monitor or the Remote Control. The monitor is turned Off and the Power Indicator turns to Red when you press the Power Button on the monitor or the Remote Control. Press again to turn On the monitor.

#### NOTE

Even when using the standby mode or turning OFF the Power Switch, the monitor will consume a small amount of electricity. Turn OFF the Power Switch or disconnect the Power Cable from the power supply whenever the monitor is not in use or during the night, to avoid unnecessary power consumption.

[Monitor]

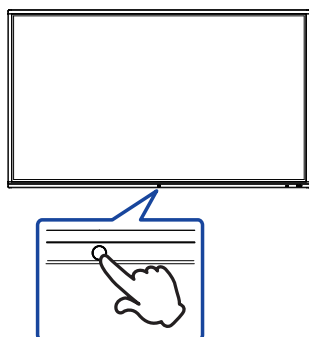

[Remote Control]



### ■ Display the adjustment menu page

The menu page appears on the screen when you press the Menu Button on the Remote Control.

The menu page disappears when you press the Back Button on the Remote Control.

[Remote Control]



### ■ Move the cursor vertically

Select adjustment by pressing the ▲ / ▼ Button on the remote control while the menu page is displayed on the screen.

[Remote Control]



### ■ Move the cursor horizontally

Select menu or setting, or perform the adjustment by pressing the ◀ / ▶ Button on the remote control while the menu page is displayed on the screen.

[Remote Control]



### ■ Adjust the volume of sound

Press the VOL- / VOL+ Button on the remote control to adjust the volume of sound when the menu page is not displayed on the screen.

#### [Remote Control]



### ■ Switch the input signal

The Input setting menu appears on the screen when you press the Input Button on the remote control.

#### [Remote Control]



## CONNECTING YOUR MONITOR

- ① Ensure that both the computer and the monitor are switched off.
- ② Connect the computer to the monitor with the signal cable.
- ③ Connect the computer to the monitor with the Touch USB Cable.
- ④ Connect the computer to the monitor with the USB Type-C Cable when viewing images on your monitor through the USB Type-C Connector or when using the monitor's USB hub function.\*
- ⑤ Connect the Power Cable to the monitor first and then to the power source.
- ⑥ Turn on your monitor (Main Power Switch and Power Button) and computer.

- \* ● When charging connected device via USB Type-C Connector, check if the device is equipped with a USB Type-C Connector that supports charging function via USB PD (=Power Delivery).
- The connected device can be charged via USB Type-C Connector even when the monitor is in standby mode.
- The USB power delivery is up to 65W. If the connected device required more than 65W for operation or for boot up (when the battery is drained), use the original power adapter that came with the device.
- If a separately purchased USB Type-C Cable is used, make sure the cable is certified by USB-IF and is full-featured with power delivery and video / audio / data transfer functions.
- USB C to A cable is not included with the monitor. If you use a USB C to A cable, please note that you can only transfer data.
- Compatibility with all connected devices is not guaranteed due to different user environments.

### NOTE

- Make sure that the building installation has a circuit breaker of 120/240V, 20A (maximum).
- The signal cables used for connecting the computer and monitor may vary with the type of computer used. An incorrect connection may cause serious damage to both the monitor and the computer. The cable supplied with the monitor is for a standard connector. If a special cable is required please contact your local iiyama dealer or regional iiyama office.
- Make sure you tighten the finger screws at each end of the Signal Cable.
- The touch function is ready for use about 5 seconds after connecting the USB cable and can be operated with a pen, finger or any other pointer.
- The Class I pluggable equipment Type A must be connected to protective earth.
- The socket-outlet shall be installed near the equipment and shall be easily accessible.
- Excessive sound pressure from ear-/headphones can cause hearing damage/hearing loss.

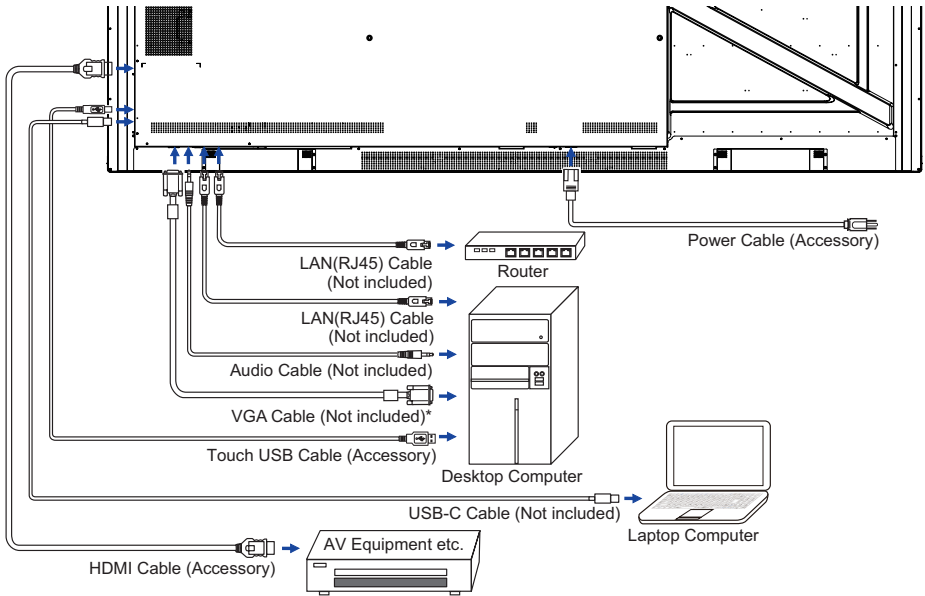

\* VGA cable is not supplied with the monitor. If you use low quality VGA cable, it may cause a result of electro-magnetic interference. Please contact the iiyama Support Centre in your country if you wish to connect the monitor via the VGA input.

## [ Connection example with the peripheral device ]

### CAUTION

Turn off the power switch and unplug the monitor and peripherals before connection to avoid an electric shock or a damage.

### NOTE

- Refer to the user manual of peripherals at the same time.
- Ensure you have the necessary cables as required.

ENGLISH

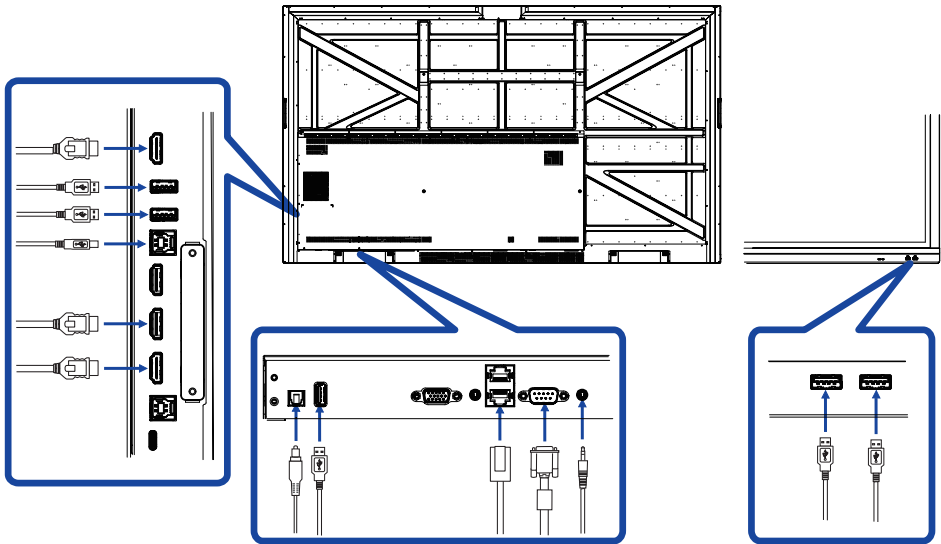



[ About the HDMI out ]

■ Example of Digital video connection

VGA

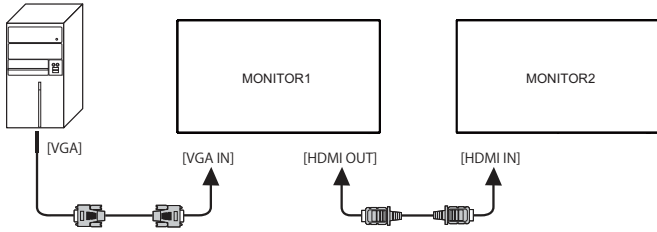

USB-C

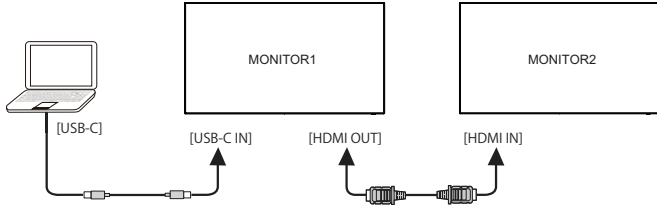

HDMI\*

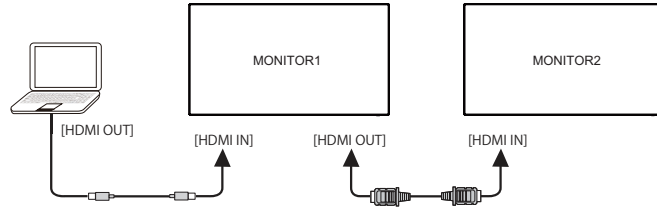

\* Not supported, enable in factory menu.

**NOTE** Connection conditions

- When 2 monitors are connected:
  - VGA input (operating at 1920 × 1080 resolution) : MONITOR1,2 (1920 × 1080)
  - USB-C input (operating at 3840 × 2160 resolution) : MONITOR1,2 (3840 × 2160)
- For the advance setting support HDMI in signal.
  - Input + 2580 (Debug Menu : HDMI OUT Enable)

## COMPUTER SETTING

### ■ Signal Timing

Change to the desired signal timing listed on page 52: COMPLIANT TIMING.

### ■ Windows XP/Vista/7/8/8.1/10 Plug & Play

The iiyama LCD monitor complies with DDC2B of VESA standard. The Plug & Play function runs on Windows /XP/Vista/7/8/8.1/10 by connecting the monitor to DDC2B compliant computer with the Signal Cable supplied.

For installation on Windows XP: The monitor Information File for iiyama monitors may be necessary for your computer and obtained via the Internet, using the address:

<http://www.iiyama.com>

### NOTE

- For additional information on how to download the driver for your touch screen monitor, please access the internet site noted above.
- Monitor Drivers are not required in most cases for Macintosh or Unix operating systems. For further information, please contact your computer dealer first for advice.

### ■ Procedure for turning ON the Power Switch

Turn ON the monitor first, and then the computer.

■ MULTI-TOUCH :

This monitor complies with DDC2B of VESA standard. (Plug&play compliant)

The MULTI-TOUCH function runs on Windows7/8/8.1/10 by connecting the monitor to DDC2B compliant computer with the USB cable supplied.

■ TOUCH support operation system :

Microsoft Windows 2000 (64 bit and 32 bit)

Microsoft Windows XP (64 bit and 32 bit)

Microsoft Windows Vista (64 bit and 32 bit)

Microsoft Windows 7 (64 bit and 32 bit)

Microsoft Windows 8/8.1/10 (64 bit and 32 bit)

Mac OS X V10.15 & higher HID for single touch only

Linux 3.0 & higher need patch for multi-touch

3.5 & higher HID for multi-touch

Not support Windows earlier versions.

	Windows 7* <sup>5</sup> ,8/8.1* <sup>6</sup> ,10* <sup>6,7,8</sup>	Windows7* <sup>4</sup>	Vista	XP	2000	Mac OSX	Linux
Default mouse* <sup>1</sup>	○	○	○	○	○	○	○
Touch digitizer* <sup>2</sup>	○	○	○	×	×	×	×
Windows gestures* <sup>3</sup>	○	×	×	×	×	×	×

\*<sup>1</sup> Default mouse (click, drag, double-click and right-click)

\*<sup>2</sup> Touch digitizer (click, drag /selection, double-click, right-click, flick and visual feedback)

\*<sup>3</sup> Digitizer with Windows7/8/8.1/10 multi-touch gestures

\*<sup>4</sup> Windows 7 - Starter and Home Basic version

\*<sup>5</sup> Windows 7 - Home Premium, Professional, Enterprise and Ultimate versions

\*<sup>6</sup> Windows 8/8.1/10 need non-OEM version for multi-touch support

\*<sup>7</sup> Windows10 - Home, Pro, Enterprise, Education, IoT Core

Not supported for Mobile and Mobile Enterprise.



\*<sup>8</sup> Windows10 - Touch do no support for "touchpad gestures". Touchpad gesture is for touchpad on notebook.

# OPERATING THE MONITOR



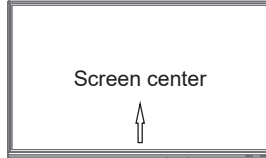

To create the best picture, your iiyama LCD monitor has been preset at the factory with the COMPLIANT TIMING shown on page 52. You are also able to adjust the picture by following the button operation shown below. For more detailed adjustments, see page 44 for SCREEN ADJUSTMENTS.

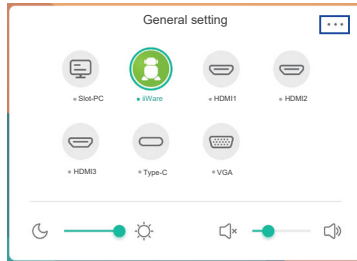

- ① Take middle point position on the bottom of display screen as starting point, use the touch pen to drag towards screen center position to call up source menu as shown below. Or press Input Button on the remote control. Click the  icon at the top right of the screen.





- ② Start the On Screen Display feature. "General setting" is displayed. Then, press the menu button on the remote control or click  on General setting menu with touch pen. There are additional Menu items which can be switched by using the  /  Buttons on the remote control or with the touch pen.



- ③ Select the Menu item of the adjustment you want to make. Use the  /  Buttons on the remote control or with the touch pen to highlight the desired adjustment item. Then, press the Enter button on the remote control.
- ④ Use the  /  Buttons on the remote control or with the touch pen to make the appropriate adjustment or setting.
- ⑤ Press the Back Button on the remote control or click blank area outside menu with the touch pen to exit menu.

For example, to correct for vertical position, select Menu item of "Adjust setting". Select "V Position" by using the  /  Buttons on the remote control or with the touch pen.

Use the  /  Buttons on the remote control or with the touch pen to change the vertical position settings. The vertical position of the overall display should be changing accordingly while you are doing this.

\* "Adjust setting" is only available for VGA input.

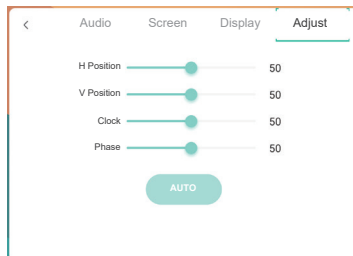

Press the Back Button on the remote control or click blank area outside menu with the touch pen, it ends, all changes are saved in the memory.

**NOTE**

- The Back Button on the remote control can be used to return previous menu item.
- Any changes are automatically saved in the memory when the On Screen Display disappears. Turning off the power should be avoided while using the Menu.
- Adjustments for Image Position, Clock and Phase are saved for each signal timing. Except for these adjustments, all other adjustments have only one setting which applies to all signal timings.

**Direct**

\* Available for Remote Control only.

- **Freeze Function:**  
Press the Blue button when Menu is not displayed.  
Repeat successively to activate/deactivate the function.
- **Backlight Function:**  
Press the Screen Off button when Menu is not displayed.  
Repeat successively to On/Off the function.
- **Input Function:**  
Press the Input Button when Menu is not displayed.
- **Volume Function:**  
Press the VOL+/VOL- Buttons when Menu is not displayed.
- **Mute Function:**  
Press the  Button when Menu is not displayed.  
Repeat successively to On/Off the function.
- **Kiosk Mode Function:**  
Disable touch functions, buttons, Menu etc.  
Turn off "iiWare Enable" in Debug menu (Input + 2580)

**[LOCK MODE]** \* Available for Remote Control only.







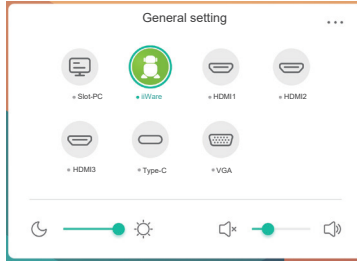

- **Front Power Button:**  
Press the Green Button when Menu is not displayed, will lock/unlock the Front Power Button.
- **Touch function:**  
Press the Yellow Button when Menu is not displayed, will lock/unlock the Touch function.
- **Front Power Button & Touch function:**
  - Press the Red Button when Menu is not displayed, will lock/unlock the Front Power Button and Touch function.

## ADJUSTMENT MENU CONTENTS

You can also access the Menu by clicking  on the desktop or  on the navigation toolbar.

### General setting







Adjustment Item	Problem / Option	Button to Press
Input * <sup>1</sup>	Slot-PC* <sup>2</sup>	Select the Slot PC input.
	iiWare	Select the iiWare input.
	HDMI1	Select the HDMI1 input.
	HDMI2	Select the HDMI2 input.
	HDMI3	Select the HDMI3 input.
	Type-C	Select the Type-C input.
	VGA	Select the VGA input.
Volume	Too soft Too loud	   
Backlight	Brightness of backlight is reduced.	   

\*<sup>1</sup> The switching of the signal input take a few seconds.

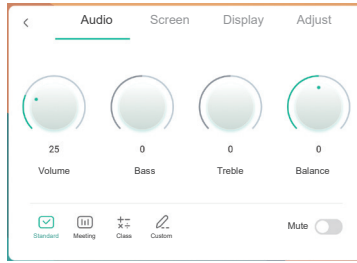
\*<sup>2</sup> Available when Slot-PC is installed only.

## Audio setting



Adjustment Item	Problem / Option		Button to Press
Volume <span style="float: right;"><b>Direct</b></span>	Too soft Too loud		
Bass	Too weak Too strong		
Treble	Too weak Too strong		
Balance	Left side speaker louder Right side speaker louder		
Sound Mode	Standard	Standard	
	Meeting	Sound quality suitable for the conference.	
	Class	Sound quality suitable for the classroom.	
	Custom	Custom sound quality.	
Mute <span style="float: right;"><b>Direct</b></span>	○	Return the sound volume to the previous level.	
		Turn off the sound.	

**Screen setting**

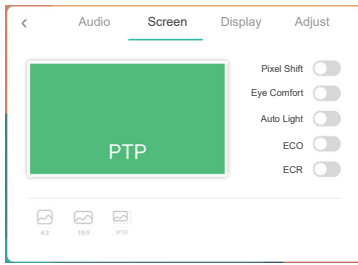



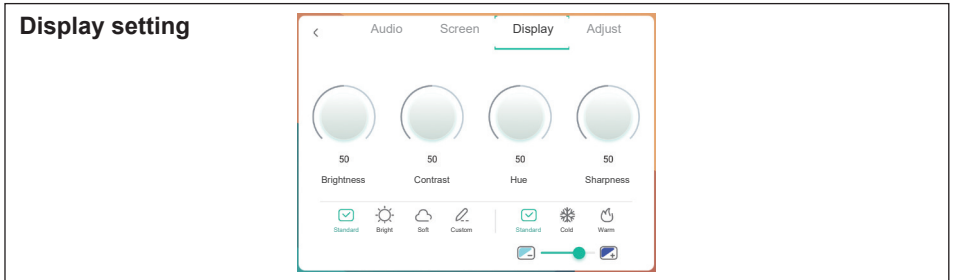

Adjustment Item	Problem / Option		Button to Press
Aspect ratio	4:3	Displays all picture in 4:3 aspect ratio.	
	16:9	Displays all picture in 16:9 aspect ratio.	
	PTP *	Display the picture point to point.	
Pixel Shift	<input type="radio"/>	The screen image will move around slightly every 2 minutes.	
		Pixel Shift is turned off.	
Eye Comfort	<input type="radio"/>	Blue light is reduced.	
		Eye Comfort is turned off.	
Auto Light	<input type="radio"/>	The image brightness can be automatically adjusted according to the ambient light.	
		Auto Light is turned off.	
ECO	<input type="radio"/>	Brightness of back-light is reduced.	
		ECO is turned off.	
ECR	<input type="radio"/>	Enhanced Contrast Ratio	
		ECR is turned off.	

\* Point To Point, to optimize touch performance when 3840 × 2160 input. (not available under Android or not 3840 × 2160 input timing)













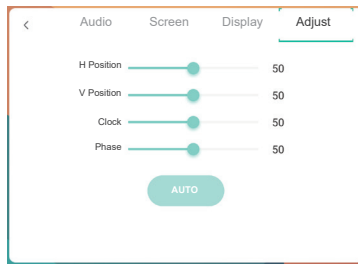











Adjustment Item	Problem / Option		Button to Press
Brightness* <sup>1</sup>	Too dark Too bright		 
Contrast	Too dull Too intense		 
Hue	Not available for this model.		
Sharpness	Not available for this model.		
Display Mode * <sup>2</sup>	Standard	For general windows environment and monitor default setting.	
	Bright	Enlarge brightness and vivid.	
	Soft	Reduce brightness and soften.	
	Custom	Displays a picture on a screen set by Image Settings adjustments.	
Color Temp	Standard	Normal color	
	Cold	Cool color	
	Warm	Warm color	
	Blue Light Reducer	Blue light is reduced. (Custom)	

\*<sup>1</sup> Adjust the Brightness when you are using the monitor in a dark room and feel the screen is too bright.

\*<sup>2</sup> Display Mode is disabled when iiWare input.

## Adjust setting \*1



Adjustment Item	Problem / Option	Button to Press
H Position	 Too far to the left	 
	 Too far to the right	 
V Position	 Too low	 
	 Too high	 
Clock	 Too narrow	 
	 Too wide	 
Phase	To correct flickering text or lines	 
Auto *2	Adjust H/V Position, Clock and Phase automatically.	

\*1 Only VGA input.

\*2 For best results, use the Auto Adjust in conjunction with the adjustment pattern. See page 44 for SCREEN ADJUSTMENTS.

**[Debug Menu]** \* Available for Remote Control only. Input + 2580

- **Initial Touch Panel**

The default settings will be restored.

- **Unknown sources: On / Off**

Enables / disables Unknown sources.

- **iiWare Enable: On / Off**

Enables / disables Kiosk mode.

- **HDMI OUT Enable: On / Off**

Enables / disables "HDMI OUT Enable" when input source is HDMI.

- **Exit**

## [Application]

### ■ Settings

Click  on the navigation toolbar with the touch pen. Then, click  with the touch pen.

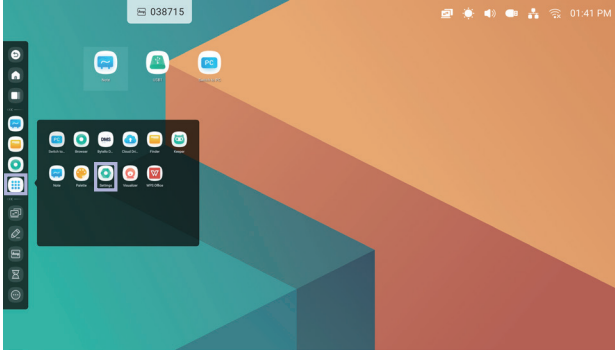



### ■ Status bar

 : Click to display the General settings.

 : Click to display the Brightness.

 : Click to display the Volume.

 : Click to display the Ethernet settings.

 : Displayed when USB flash drive is connected. Click to access your USB flash drive in the Finder application.

 : Click to display the Hotspot settings.

 : Displayed when WiFi module is inserted. Click to display the WiFi Settings.

01:41(Clock) : Click on the clock display to display the Date & Time of Settings.

 xxxxxx :

When connecting a LAN or Option WiFi module, the password for a notebook or a smartphone, etc. to connect to ScreenSharePro, is displayed on the screen. (Automatically generated)

## [ Settings ]

Adjustment Item	Problem / Option		Button to Press	
Wireless & network	WiFi*1,2	Set the WiFi function On / Off and pairing to WiFi device.		
	Ethernet	Set the wired network. Network : On / Off, Mac Adress, IP adress, Default gateway, Netmask, DNS, Proxy		
	Hotspot*1,2	Set the Hotspot function. Network : On/Off, SSID, Password, DHCP settings		
	Bluetooth*1	Set the Bluetooth function On / Off and pairing to Bluetooth device.		
	VPN	Set the VPN.		
Personal	Wallpaper	Set the Wallpaper. (Stills, Dynamic)		
	Swipe up options at the bottom	Swipe to display the options at the bottom. (Bottom Sidebar / Source Menu)		
	SystemBar Channel Settings	Set the shortcut menu. Available in all channels / Available in iiWare / Disable in all channels / Available in all channels except PC		
	Multi-Window mode	Set the Multi-Window mode On/Off.		
Input & Output	Sound	Touch Sounds : On / Off Sound Output Settings : Speaker / Headphone / Line Out		
	Input settings	Input Naming Settings	Input Alias Switch : On / Off Change the Input name to Nickname.	
	External Source Display Settings	HDMI OUT Format : 3840 x 2160_60Hz / 1080P_60Hz / 480P_60Hz Type-C Format : 4K, 60Hz, USB2.0 / 4K, 30Hz, USB3.0		
Application	Application management Show System, Reset App Preferences			
System	Date & Time	Set the Date and Time. Use 24-Hour Format, Automatic Date & Time, Date Format, Timezone		
	Language & Keyboard	Set display language, keyboard and input method. Language: Catala / Čeština / Deutsch / English / Español / Français / Italiano / Nederlands / Polski / Русский		
	Lock Screen Password	Set the password. (4-digit) Set/Clear password, Change password		
	Startup & shutdown	Startup channel	Last shutdown channel / Slot-PC*3 / iiWare / HDMI1 / HDMI2 / HDMI3 / Type-C / VGA	
		Standby after startup (black screen) : Turn off the backlight.		
<b>NOTE</b> Press the Screen Off button on the remote control or touch the screen to return to the screen.				
Auto Power off : Enable the Auto Power off function.			<b>NOTE</b> The Auto Power off function is enabled as default setting. The monitor turns off automatically 4 hours after the key or touch operation stops. Disable Auto Power off function when you use the monitor continuously for more than 4 hours.	

[  Settings ]

Adjustment Item	Problem / Option			Button to Press
System	Startup & shutdown	Start up logo	iiyama Logo displayed when the monitor is turned on.	
		Timer Switch	Power off reminder : On / Off	
			Add Boot Task / Add Off Task	Select the time of each, and select day of the week or everyday or the business days.
	Email	Set the Email.		
	Printing	Set the Network or WiFi direct printer.		
	Storage	To display the internal system and USB disk.		
	Security	Credential storage (Trusted Credentials, User Credentials), Install From Storage, Clear Credentials, Unknown sources* <sup>4</sup> : On / Off		
System update	Check and update to latest FirmWare version.			

\*<sup>1</sup> WiFi, Hotspot and Bluetooth can only be used when Option WiFi Module or Slot-PC is installed.

\*<sup>2</sup> WiFi will be turned off when the Ethernet is turned on.

\*<sup>3</sup> Available only when Option Slot-PC is installed.

\*<sup>4</sup> APK from unknown sources can be installed, the installation is done on customer own risk, manufacture will not take any responsibility and not give any support for the installed APK's.  
Input + 2580 (Debug Menu : Unknown sources)

## ■ Navigation toolbar appears

The navigation toolbar can be displayed on either left side or right side of the screen.

 : Back

 : Home

 : Back Stage

Clean all : Remove all in-progress apps

### - Application -

You can customize up to 7 apps from "All Apps" to the navigation bar. (Drag and drop the app icon)

 : Note

 : Finder

 : Settings

 : All Apps (Switch to PC, Browser, Cloud Drive, ESHARE Pro, Finder, Keeper, Note, Palette, Settings, Vivalizer, WPS Office)

### - Tools -

You can customize up to 4 tools from "More" to the navigation bar.

(Click Edit in the "More" window or press and hold the icon. And add/remove to from the navigation bar by clicking the "+" / "-" displayed on the icon.)

 : Touch Menu

 : Mark

Pen: Annotate

Brush: Marker

Clean: Clean the annotations, Gesture eraser

Save: Save current annotations in the screen content to picture in the storage.

Share: Share Annotation

Users can scan the QR code with a smartphone and download the annotation image to a smartphone.

Cloud: Google Drive / One Drive

#### Save to Cloud Drive

Users can save notes and annotations in Note directly to one of the cloud drives by clicking on the Cloud Storage icon in the menu. To change the way files are saved to the Cloud Drive, users can select two options in the cloud storage overview.

#### Use the default account

When checked, all notes will be saved automatically to the default Cloud Drive. Users will not be able to select a cloud drive.

#### Use the default file name when save

When checked, all notes will be saved to the selected Cloud Drive with the default file name. Users will not be able to (re)name the file.

Close: Exit

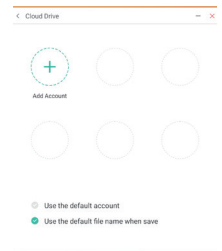

 : ScreenShare Pro  
ScreenShare Pro is a multi-screen interaction software for smartphone to interactive intelligent panel. ScreenSharePro activation code included in optional WiFi Module OWM002/SI07. (The device such as a computer or smartphone on the same network.)

Mirroring: It is an application that displays the screen of a device such as a computer or smartphone on the monitor.

Desktop Sync: It is an application that can control the screen of Monitor by displaying it on a device such as a computer or Smartphone.

Remote: It is an application that allows to remotely control the monitor on a smartphone. The Smartphone works as a Mouse/Touchpad for the screen.

Airplay/Chromecast: The device without installed ScreenShare Pro app can still connect to ScreenSharePro via Airplay/Chromecast. (Compatibility is not guaranteed)

miracast: The device without installed ScreenShare Pro app can still connect to ScreenSharePro via miracast. (Compatibility is not guaranteed)

 : Timer (CountDown)

 : Crop (Screen Capture)

Freedom size

Full size

Window size

Save: Save in internal storage

Insert: Edit the captured image in Note, send to Note

Exit

 : StopWatch

 : AirClass(WiFi Teamwork)

(Available when the optional WiFi Module OWM002/SI07 is installed or with a working LAN connection. Participants need to be on the same network.)

Voter / Responder / Selector / Message / Manager / Exit

 : SpotLight

Setting: Zoom / Clarity

Exit

 : Freeze (Freeze the picture)

Zoom +

Zoom -

Full-screen

Close: Exit

 : Screen Lock (Lock/unlock the screen)

Lock / unlock is possible by setting "Lock Screen Password" in Settings.

 : More (All tools)

 : Clean (Remove in-progress tool)

CloudDrive Account / Whiteboard end and format files in Finder / Browser history will be remove.



## ■ Shortcut

### - App -

Drag and drop the App icon from "All apps" to create a shortcut icon on the screen.

### - File / Folder -

Drag and drop a File or Folder from the Finder to create a shortcut icon on the screen.

### - Website -

Create a shortcut by opening the desired website and clicking "Send the quick-link to Desktop" in the settings menu.

### - Move -

Move by long-pressing the icon and dragging and dropping.

### - Remove -

Remove it by long-pressing the icon and clicking Remove from the menu.

## ■ Multi-Windows

To use the Multi-Windows feature, first turn on Settings > Personal > Multi-Window Mode.

- Resize Windows to display 4 apps on the screen at the same time.

- Drag content between apps.

Press and hold the image on the browser and drag the image to NOTE.

<Support>

Image : NOTE, Finder, Photos

Text : NOTE, Finder

<How to use AirClass>

- ① The teacher click the  AirClass.
- ② Use the device to scan the QR code. (device: Android and mobile device on the same network) The students can also join the class by entering the URL in browser.
- ③ After all students have joined the class, click "ENTER THE CLASS".

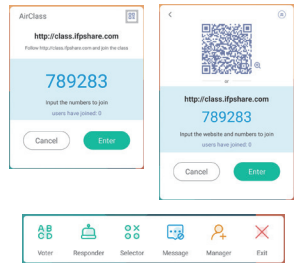

- ④ Answer
  1. The teacher write a question on the note and click the Voter.
  2. The teacher select Single Choice Mode or Multiple Choice Mode.
  3. The number of students who are logged in is displayed. Then click BEGIN.
  4. After the student submitted the answer, the teacher can click "Finish", and the answer's statistics data will be shown on the screen.
  5. Teacher selects the correct answer on the screen; the correct answer will be green coloured, and the wrong answer will be red coloured.

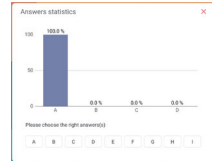
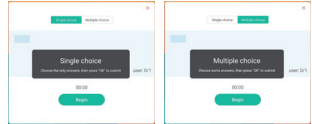

- ⑤ Responder
 

After teacher clicks the Responder. The 1st student who clicks the "Be Fast" icon the Notebook/Smartphone will be selected.

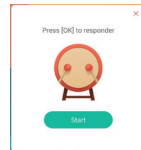

- ⑥ Selector
 

The teacher can click on the Selector to randomly select one student to answer the questions.

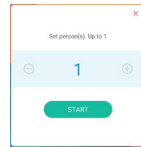

- ⑦ Message
  1. The teacher can enable the Message function to allow students' messages be presented on the screen.

Student message

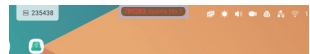

- ② The students write their own opinions on their Notebook or Smartphone and click to Send.

- ⑧ Manager
 

The teacher can click the Manager to display the QR code to let other students to enter the class at any time.

**[Note]**

This is a writing software.

Can write the characters, Lines and pictures like a whiteboard. Also, can insert an image or file.

**Click  with the touch pen.**

**- Tools -**

**Menu:** Display menu of Note.

**New:** Save the Note writing and open a new Note.

**Open:** Open the file.

**Save:** Save the current document to image format to file browser.

**Import:** Import the picture. (IMG/PDF/SVG)

**Export :** Export as IMG/PDF/SVG/IWB.

**Cloud Storage:** Google Drive / One Drive

**Save to Cloud Drive**

Users can save notes and annotations in Note directly to one of the cloud drives by clicking on the Cloud Storage icon in the menu. To change the way files are saved to the Cloud Drive, users can select two options in the cloud storage overview.

**Use the default account**

When checked, all notes will be saved automatically to the default Cloud Drive. Users will not be able to select a cloud drive.

**Use the default file name when save**

When checked, all notes will be saved to the selected Cloud Drive with the default file name. Users will not be able to (re)name the file.

**Background:** Change the color of the background.

**Send Email:** Send the captured image by Email.

**Customise taskbar:** You can customize the taskbar by choosing tool from the "Customize taskbar".

**Brightness disabled/enabled:** Enabled: Reducing the brightness automatically when writing the Note.

**Exit:** Return to main screen.

**Share:** Share Note

Users can scan the QR code with a smartphone and download the annotation image to a smartphone.

**List:** List up all the opened Notes.

**Select:** Select the object being edit, can move, can zoom.

**Pen:** Change the width and color of the stroke. (Pen/Handwriting size/Handwriting color)

**Eraser:** Erase the specified object.

**Clean All:** Erase the all object.

**Ruler:** Ruler function

**Shape:** Draw the shape.

**Table:** Table creation

**Sticky-Notes:** Brainstorming tool

**Preview:** Display image

**Undo:** Cancel

**Redo :** Redo

**Add:** Add new page after the last page.

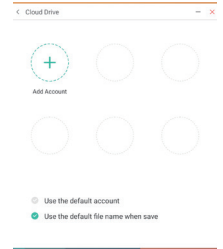

< : To the previous page.

> : To the next page.

2/7 : Page number

**- Extension function of the pen -**

After selecting the handwriting, the handwriting can be turn to intelligent text and for further processing.

Tools : Color, Smartwrite, Search, Flip, Top, Clone, Delete

**- Image expansion function -**

After selecting the image, the image can be transformed into vector image, and the image can be mirrored.

Tools : Crop, SVG, Flip, Top, Clone, Delete

## [Finder (File Browser)]

Click  with the touch pen.

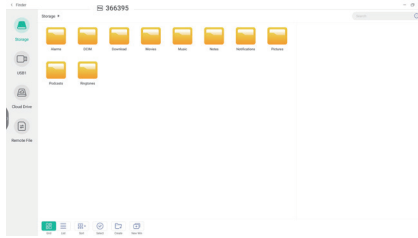

Browse the files stored in the internal storage device, the USB storage, Cloud Drive and Remote File.

### ● Supported Format

DOC : PPT, Word, Excel, PDF (Open the file by using the WPS Office)

Note : Note files, screenshot

Movie : .3g2 .3gp .avi .flv .f4v .mkv .mov .mp4 .VOB .mpg/MPEG .ts

Picture : .jpg .jpeg .png .bmp .gif

Music : .aac .ape .flac .m4a .mp3 .ogg .wav

### - Tools -

: Search

: Minimization

: Maximization / restoration

: Exit

: Grid

: List

: Sort (Sorts Name, Time, Size, Type.)

: Select

: Select All

: Cancel

: Create

: New Win

: Copy

: Paste

: Cut

: Delete

: Rename

: Send

## Cloud Drive (Google Drive / One Drive)

### **Save to Cloud Drive**

Users can save notes and annotations in Note directly to one of the cloud drives by clicking on the Cloud Storage icon in the menu. To change the way files are saved to the Cloud Drive, users can select two options in the cloud storage overview.

### **Use the default account**

When checked, all notes will be saved automatically to the default Cloud Drive. Users will not be able to select a cloud drive.

### **Use the default file name when save**

When checked, all notes will be saved to the selected Cloud Drive with the default file name. Users will not be able to (re)name the file.

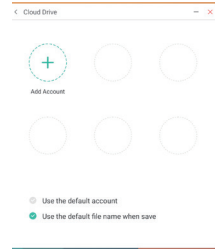

## Remote File

Support access to SAMBA(SMB1.0) and FTP server.

**[Clean]**

Clear the following :

CloudDrive Account / Whiteboard enb format files in Finder / Clear browser history browsing content

Click  with the touch pen.

**[Browser (Web Browser)]**

Connect the network, and browse the web.

Click  with the touch pen.

**[Cloud Drive]**

Connect the network, and the Cloud Drive.

Click  with the touch pen.

**[EShare Pro]**

EShare is a multiscreen interaction application which makes the user experience natural and enjoyable for home entertainment, business presentation, and educational training.

Click  with the touch pen.

**[iMirror]**

This is software which can display an image of a smartphone on the monitor.

Click  with the touch pen.

**[Keeper]**

This is the software to clean up the running application.

Double click  with the touch pen.

One Key Optimize : Memory and Garbage clean

Memory Clean : Clean memory

Garbage Clean : Clean storage

**[Palette]**

This is an illustration writing software.

Click  with the touch pen.

**[Visualizer]**

Visualizer is an app that allows users to connect webcam or visualizer(document camera) for capturing live instructions or physical materials and then projecting them onto a display for viewing and annotating.

Click  with the touch pen.

**[WPS Office]**

This is the software to use the file of the Office.

Double click  with the touch pen.

## SCREEN ADJUSTMENTS

Adjust the image by following the procedure below to get the desired picture when selecting Analog input.

- The screen adjustments described in this manual are designed to set image position and minimize flicker or blur for the particular computer in use.
- The monitor is designed to provide the best performance at resolution of 1920 × 1080, but can not provide the best at resolutions of less than 1920 × 1080 because the picture is automatically stretched to fit the full screen. It is recommended to operate at resolution of 1920 × 1080 in normal use.
- Displayed text or lines will be blurred or irregular in thickness when the picture is stretched due to the screen enlargement process.
- It is preferable to adjust the image position and frequency with the monitor controls, rather than the computer software or utilities.
- Perform adjustments after a warm-up period of at least thirty minutes.
- Additional adjustments may be required after the Auto Adjust depending on the resolution or signal timing.
- The Auto Adjust may not work correctly when displaying the picture other than the screen adjustment pattern. In this case, manual adjustments are required.

There are two ways to adjust the screen. One way is automatic adjustment for Position, Clock Frequency and Phase. The other way is performing each adjustment manually.

Perform the Auto Adjust first when the monitor is connected to a new computer, or resolution is changed. If the screen has a flicker or blur, or the picture does not fit in the display area after performing the Auto Adjust, manual adjustments are required. Both adjustments should be made by using the screen adjustment pattern (Test.bmp) obtained via the Iiyama web site (<http://www.iiyama.com>).

Adjust the image by following the procedure below to get the desired picture.

This manual explains adjustment under Windows OS.

- ① **Display the picture at the optimum resolution.**
- ② **Enter the Test.bmp (screen adjustment pattern) to wallpaper.**

### NOTE

- Consult the appropriate documentation for doing this.
- Set the display position to center in the wallpaper setting dialogue box.

[Adjustment pattern]

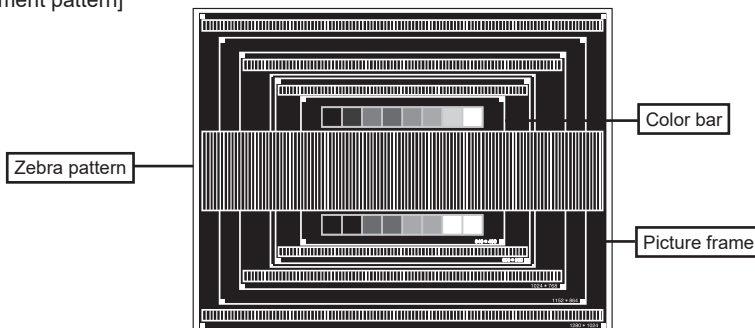



- ③ Perform the Auto Adjustment.
- ④ Adjust the image manually by following procedure below when the screen has a flicker or blur, or the picture does not fit in the display area after performing the Auto Adjust.
- ⑤ Adjust the V Position so that the top and bottom of the picture frame will fit to the display area.

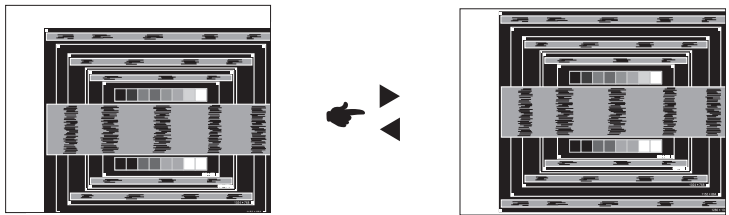

- ⑥ 1) Adjust the H Position so that the left side of the picture frame will move to the left edge of the display area.

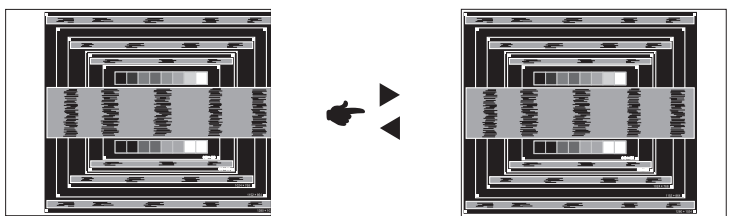

- 2) Stretch the right side of the picture frame to the right edge of the display area by adjusting the Clock.

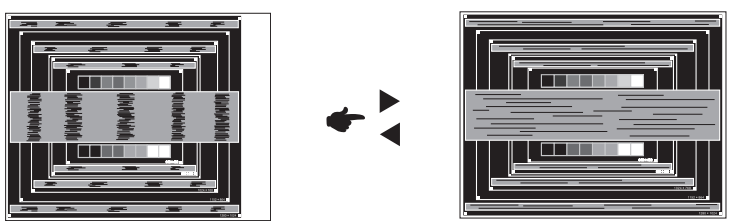

- NOTE**
- When the left side of the picture frame moves apart from the left edge of the display area during the Clock adjustment, adjust steps 1) and 2).
  - Another way to make the Clock adjustment is to correct the vertical wavy lines in the zebra pattern.
  - The picture may flicker during the Clock, H/V Position adjustment.
  - In case the picture frame is bigger or smaller than the data display area after the Clock adjustment, repeat steps from ③.

- ⑦ **Adjust the Phase to correct horizontal wavy noise, flicker or blur in the zebra pattern.**

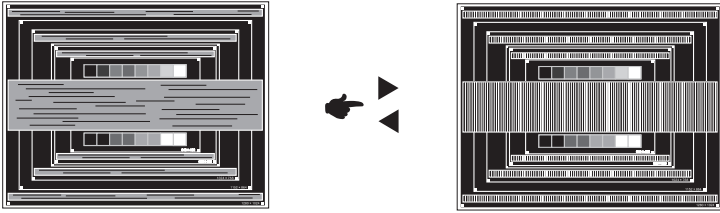

**NOTE**

- In case the strong flicker or blurs remain on a part of the screen, repeat steps ⑥ and ⑦ because the Clock may not be adjusted correctly.
  - Adjust the H Position after the Phase adjustment if the horizontal position moves during the adjustment.
- ⑧ **Adjust the Brightness and Color to get the desired picture after you complete the Clock and Phase adjustments.**
- Put back your favorite wallpaper.**

## STANDBY FEATURE

The standby feature of this product complies with power saving requirement of VESA DPMS. When activated, it automatically reduces unnecessary power consumption of the monitor when your computer is not in use.

To use the feature, the monitor needs to be connected to a VESA DPMS compliant computer. There is a standby step the monitor takes as described below. The standby function, including any timer settings is configured by the operating system. Check your operating system manual for information on how this can be configured.

### ■ Standby Mode

When the video signal from the computer is off, the monitor enters into Standby Mode which reduces the power consumption to less than 0.5W. The screen becomes dark, and the power indicator turns to red. From Standby Mode, the image reappears in several seconds when either the keyboard or the mouse are touched again.

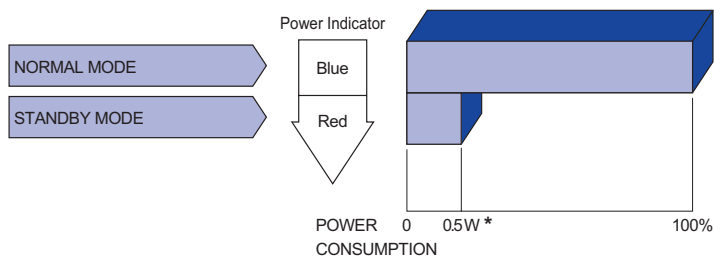

\* USB peripherals and audio equipment are not connected.

### NOTE

Even when using the standby mode, the monitor consumes electricity. Turn off the Power Switch whenever the monitor is not in use, during the night and weekends, to avoid unnecessary power consumption.

# TROUBLE SHOOTING

If the monitor fails to operate correctly, please follow the steps below for a possible solution.

1. Perform the adjustments described in OPERATING THE MONITOR, depending on the problem you have. If the monitor does not get a picture, skip to 2.
2. Consult the following items if you cannot find an appropriate adjustment item in OPERATING THE MONITOR or if the problem persists.
3. If you are experiencing a problem which is not described below or you cannot correct the problem, discontinue using the monitor and contact your dealer or iiyama service center for further assistance.

## Problem

## Check

- |  |   |
|--|---|
| ① The picture does not appear.<br>(Power indicator does not light up.) | <input type="checkbox"/> The Power Cable is firmly seated in the socket.<br><input type="checkbox"/> The Power Switch is turned ON.<br><input type="checkbox"/> The AC socket is live. Please check with another piece of equipment.  |
| (Power indicator is blue.)   | <input type="checkbox"/> If the blank screen saver is in active mode, touch the keyboard or the mouse.<br><input type="checkbox"/> Increase the Contrast and/or Brightness.<br><input type="checkbox"/> The computer is ON.<br><input type="checkbox"/> The Signal Cable is properly connected.<br><input type="checkbox"/> The signal timing of the computer is within the specification of the display. |
| (Power indicator is red.)  | <input type="checkbox"/> If the monitor show "No Signal", touch the keyboard or the mouse.<br><input type="checkbox"/> The computer is ON.<br><input type="checkbox"/> The Signal Cable is properly connected.<br><input type="checkbox"/> The signal timing of the computer is within the specification of the display.  |
| ② The screen is not synchronized.                                      | <input type="checkbox"/> The Signal Cable is properly connected.<br><input type="checkbox"/> The signal timing of the computer is within the specification of the monitor.  |
| ③ The screen position is not in the center.                            | <input type="checkbox"/> The signal timing of the computer is within the specification of the monitor.  |
| ④ The screen is too bright or too dark.                                | <input type="checkbox"/> The video output level of the computer is within the specification of the monitor.   |
| ⑤ The screen is shaking.   | <input type="checkbox"/> The power voltage is within the specification of the monitor.<br><input type="checkbox"/> The signal timing of the computer is within the specification of the monitor.  |
| ⑥ No sound.  | <input type="checkbox"/> The audio equipment (computer etc.) is ON.<br><input type="checkbox"/> The Audio Cable is properly connected.<br><input type="checkbox"/> The Volume is turned up.<br><input type="checkbox"/> The Mute is OFF.<br><input type="checkbox"/> The audio output level of the audio equipment is within the specification of the monitor.  |
| ⑦ The sound is too loud or too quiet.                                  | <input type="checkbox"/> The audio output level of the audio equipment is within the specification of the monitor.  |
| ⑧ A strange noise is heard.  | <input type="checkbox"/> The Audio Cable is properly connected.   |

### Problem

### Check

- |  |   |
|--|---|
| ⑨ The touch screen shows no response.  | <input type="checkbox"/> The USB Cable is firmly seated in the socket.<br><input type="checkbox"/> Touch screen driver software is installed. |
| ⑩ The touch position does not deviate. | <input type="checkbox"/> The calibration function set up correctly.   |

## RECYCLING INFORMATION

For better environment protection please don't dispose your monitor.  
Please visit our web site: [www.iiyama.com](http://www.iiyama.com) for monitor recycling.

# APPENDIX

Design and specifications are subject to change without prior notice.

## SPECIFICATIONS : ProLite TE9804MIS

ENGLISH

Touch Screen	Technology	IR Touch 20points
	Light transmission	88%
	Hardness	7H
	Thickness	4mm
	Communication system	USB serial transfer
	Response time	10ms
Size Category		98"
LCD Panel	Panel technology	IPS
	Size	Diagonal: 97.52" (247.65cm)
	Pixel pitch	0.5622mm H × 0.5622mm V
	Brightness	350cd/m <sup>2</sup> (Typical)
	Contrast ratio	1200 : 1 (Typical: without glass)
	Viewable angle	Horizontal : 178 degrees, Vertical: 178 degrees (Typical)
	Response time	8ms (Typical, Gray to Gray)
Display Colors		Approx.1.07B
Sync Frequency		VGA: Horizontal: 30.0-80.0kHz, Vertical: 50-60Hz HDMI1/2/3: Horizontal: 30.0-135.0kHz, Vertical: 24-60Hz USB-C 3.1 Gen1: Horizontal: 30.0-135.0kHz, Vertical: 24-60Hz
Native Resolution		3840 × 2160, 8.3 MegaPixels
Supported max. resolution		VGA: 1920 × 1080 60Hz HDMI1/2/3: 3840 × 2160 60Hz (YUV420/RGB444/YUV444) USB-C 3.1 Gen1: 3840 × 2160 60Hz
Input Connector		VGA ×1, HDMI ×3, USB-C ×1
USB Standard		USB2.0 (DC5V, 500mA) ×1 (for software update) USB3.0 (DC5V, 900mA) ×4 (Front: 2, Side: 2) USB-C 3.1 Gen1 (5V, 3A / 9V, 3A / 12V, 3A / 20V, 3.25A) ×1 (DisplayPort 1.4 ALT mode/Touch/Power Delivery 65W)
Number of USB Ports Connector shape		1 : Type C 2 Upstream : Type B (for touch) 5 Downstream : Type A
Input Audio Connector		ø 3.5mm mini jack (Stereo)
LAN		RJ45 ×2
Serial Port		RS-232C In
Plug & Play		VESA DDC2B™
Input Sync Signal		Separate sync: TTL, Positive or Negative
Input Video Signal		Analog: 0.7Vp-p (Standard), 75Ω, Positive Digital: HDMI, USB-C 3.1 Gen1 (DisplayPort 1.4)
Input Audio Signal		2.0Vrms maximum
Output Connector		HDMI 3840 × 2160 60Hz
SPDIF out Connector		SPDIF
Headphone Connector		ø 3.5mm mini jack (Stereo)

Speakers	Internal: 2 Typical: 16W (Stereo speakers)
iiWare Version	V9.0
Maximum Screen Size	2162.0mm W × 1217.4mm H / 85.1" W × 47.9" H
Power Source	100-240VAC, 50/60Hz, 6.0A
Power Consumption*	222W typical, Standby mode: 0.5W maximum
Dimensions / Net Weight	2244.5 × 1323.0 × 90.5mm / 88.4 × 52.1 × 3.6" (W×H×D) 103.55kg / 228.29lbs
Environmental Considerations	Operating: Temperature 0 to 40°C / 32 to 104°F Humidity 10 to 90% (No condensation) Storage: Temperature -20 to 60°C / 4 to 140°F Humidity 10 to 90% (No condensation)
Approvals	CE, UKCA

**NOTE** \* USB peripherals and audio equipment are not connected.

**DIMENSIONS**

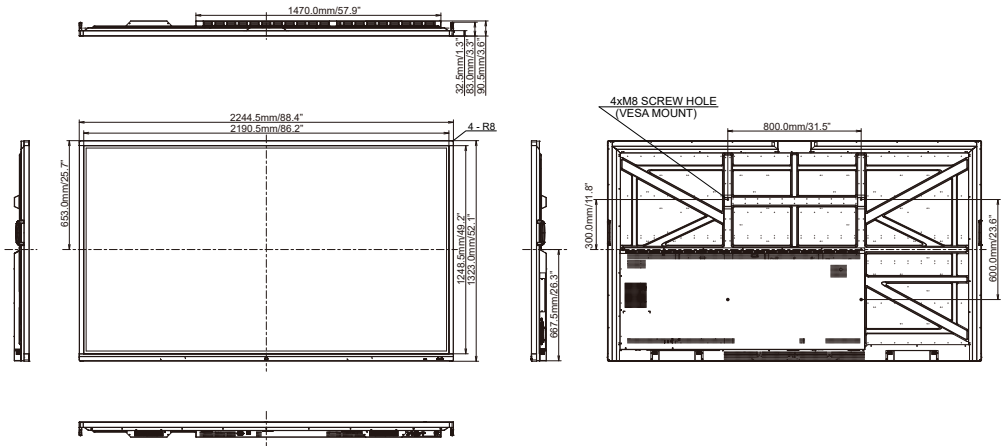

## COMPLIANT TIMING

Timing		fH(kHz)	fV(Hz)	Dot clock (MHz)	VGA	HDMI1	HDMI2	HDMI3	USB-C (DisplayPort)
VESA	VGA 640x480	31.5	60.0	25.175	○	○	○	○	○
	SVGA 800x600	37.9	60.0	40.000	○	○	○	○	○
	XGA 1024x768	48.4	60.0	65.000	○	○	○	○	○
	WXGA 1280x768	47.8	60.0	79.500	○	○	○	○	○
	QVGA 1280x960	60.0	60.0	108.000	○	○	○	○	○
	SXGA 1280x1024	64.0	60.0	108.000	○	○	○	○	○
	HD FWXGA 1366x768	47.7	60.0	85.500	○	○	○	○	○
	CVT 1400x900	55.9	60.0	106.500	○	○	○	○	○
	WSXGA 1680x1050	65.3	60.0	146.250	○	○	○	○	○
	FHD 1920x1080	67.5	60.0	148.500	○	○	○	○	○
4K 3840x2160	67.5	30.0	297.000		○	○	○	○	
	112.5	50.0	594.000		○	○	○	○	
	135.0	60.0	594.000		○	○	○	○	
IBM	720x400	31.5	70.0	28.320	○	○	○	○	
SD	NTSC-M	15.7	60.0	13.500					
	NTSC-J	15.7	60.0	13.500					
	PAL-BDGHI	15.7	60.0	13.500					
	480i 60Hz	15.7	60.0	13.500		○	○	○	
	576i 50Hz	15.6	50.0	13.500		○	○	○	
	480p 60Hz	31.5	60.0	27.000		○	○	○	
576p 50Hz	31.3	50.0	27.000		○	○	○		
HD	720p 50Hz	37.5	50.0	74.250		○	○	○	
	720p 60Hz	45.0	60.0	74.250		○	○	○	
	1080i 50Hz	28.1	50.0	74.250		○	○	○	
	1080i 60Hz	33.8	60.0	74.250		○	○	○	
	1080p 50Hz	56.3	50.0	148.500		○	○	○	
	1080p 60Hz	67.5	60.0	148.500		○	○	○	

\* ○ means supported the timing.