

USER MANUAL

ProLite

LCD Monitor

ENGLISH

ProLite XUB2595WSU
ProLite XU2595WSU

Thank you very much for choosing the iiyama LCD monitor.

We recommend that you take a few minutes to read carefully through this brief but comprehensive manual before installing and switching on the monitor. Please keep this manual in a safe place for your future reference.



Dear user, we congratulate you on the purchase of your iiyama LCD.

For details on warranty and locally used pixel policies that apply directly after installation of your product please check the iiyama website.

To report a fault, please contact your local support centre found at www.iiyama.com/service

Things to check before you call the iiyama information line

- | if the power cable is connected securely and turned on?
- | if the display has been turned on?
- | if the signal cable is connected securely and the correct input selected?
- | if the computer has been restarted with the display connected?
- | if the graphics card is correctly installed with the latest drivers possible?
- | if the correct native resolution has been selected via 'Display Properties'?
- | If the R/G/B signal configuration is correct?
- | if the displays On Screen Menu is shown?
- | if the correct brightness and contrast settings have been set?
- | if given display tolerances and compatibility have been considered?
- | if via the On Screen Menu you have performed a Factory Reset/Recall?

Before reporting the screen defect, please prepare the following information/evidence:

- | model number *
- | purchase receipt and serial number *
- | name and address for collection
- | telephone/fax number, for availability during the day
- | convenient collection date (date, time)
- | short description of the defect

Important Note:

If there is no fault found in the collected equipment after inspection, the transferring party shall incur charges for transport and administration.

If you have checked all of the above and there is still no picture, call our information line for assistance in your country.

* see the identification plate on the back of the case.

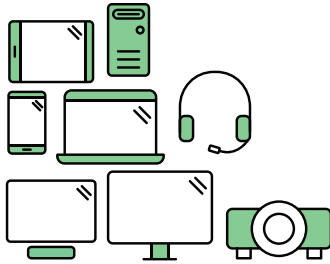

Say hello to a more sustainable product

IT products are associated with a wide range of sustainability risks throughout their life cycle. Human rights violations are common in the factories. Harmful substances are used both in products and their manufacture. Products can often have a short lifespan because of poor ergonomics, low quality and when they are not able to be repaired or upgraded.

This product is a better choice. It meets all the criteria in TCO Certified, the world's most comprehensive sustainability certification for IT products. Thank you for making a responsible product choice, that help drive progress towards a more sustainable future!

Criteria in TCO Certified have a life-cycle perspective and balance environmental and social responsibility. Conformity is verified by independent and approved verifiers that specialize in IT products, social responsibility or other sustainability issues. Verification is done both before and after the certificate is issued, covering the entire validity period. The process also includes ensuring that corrective actions are implemented in all cases of factory non-conformities. And last but not least, to make sure that the certification and independent verification is accurate, both TCO Certified and the verifiers are reviewed regularly.

Want to know more?

Read information about TCO Certified, full criteria documents, news and updates at [tcocertified.com](https://www.tcocertified.com). On the website you'll also find our Product Finder, which presents a complete, searchable listing of certified products.

CE MARKING DECLARATION OF CONFORMITY

This LCD monitor complies with the requirements of the EC/EU Directive 2014/30/EU "EMC Directive", 2014/35/EU "Low Voltage Directive", 2009/125/EC "ErP Directive" and 2011/65/EU "RoHS Directive".

The electro-magnetic susceptibility has been chosen at a level that gives correct operation in residential areas, business and light industrial premises and small-scale enterprises, inside as well as outside of the buildings. All places of operation are characterised by their connection to the public low voltage power supply system.

IYAMA CORPORATION: Wijkerveerstraat 8, 2131 HA Hoofddorp, The Netherlands

Model No. : PL2595W



We recommend recycling of used product. Please contact your dealer or iiyama service center. Recycle information is obtained via the Internet, using the address:
<http://www.iiyama.com>

You can access the Web page of different countries from there.

- We reserve the right to change specifications without notice.
- All trademarks used in this user manual are the property of their respective owners.
- Eprel registration number XUB2595WSU-B1 : 356026, XU2595WSU-B1 : 356025

TABLE OF CONTENTS

FOR YOUR SAFETY.....	1
SAFETY PRECAUTIONS.....	1
SPECIAL NOTES ON LCD MONITORS.....	3
CUSTOMER SERVICE.....	3
CLEANING.....	3
BEFORE YOU OPERATE THE MONITOR.....	4
FEATURES.....	4
CHECKING THE CONTENTS OF THE PACKAGE.....	4
INSTALLATION.....	5
FITTING AND REMOVAL OF BASE : ProLite XUB2595WSU.....	7
FITTING AND REMOVAL OF BASE : ProLite XU2595WSU.....	8
CONTROLS AND CONNECTORS : ProLite XUB2595WSU.....	9
CONTROLS AND CONNECTORS : ProLite XU2595WSU.....	10
CONNECTING YOUR MONITOR : ProLite XUB2595WSU.....	11
CONNECTING YOUR MONITOR : ProLite XU2595WSU.....	12
DISCONNECTING YOUR MONITOR.....	13
COMPUTER SETTING.....	13
ADJUSTING THE HEIGHT AND THE VIEWING ANGLE :	
ProLite XUB2595WSU.....	13
ADJUSTING THE VIEWING ANGLE : ProLite XU2595WSU.....	14
OPERATING THE MONITOR.....	15
ADJUSTMENT MENU CONTENTS.....	16
SCREEN ADJUSTMENTS.....	22
STANDBY FEATURE.....	25
TROUBLE SHOOTING.....	26
RECYCLING INFORMATION.....	27
APPENDIX.....	28
SPECIFICATIONS : ProLite XUB2595WSU.....	28
SPECIFICATIONS : ProLite XU2595WSU.....	29
DIMENSIONS : ProLite XUB2595WSU.....	30
DIMENSIONS : ProLite XU2595WSU.....	30
COMPLIANT TIMING.....	31

FOR YOUR SAFETY

SAFETY PRECAUTIONS

WARNING

STOP OPERATING THE MONITOR IF YOU ARE AWARE OF ANY PROBLEMS

If you notice any abnormal phenomena such as smoke, strange sounds or fumes, unplug the monitor and contact your dealer or iiyama service center immediately. Further use may be dangerous and can cause fire or electric shock.

NEVER REMOVE THE CABINET

High voltage circuits are inside the monitor. Removing the cabinet may expose you to the danger of fire or electric shock.

DO NOT PUT ANY OBJECT INTO THE MONITOR

Do not put any solid objects or liquids such as water into the monitor. In case of an accident, unplug your monitor immediately and contact your dealer or iiyama service center. Using the monitor with any object inside may cause fire, electric shock or damage.

INSTALL THE MONITOR ON A FLAT, STABLE SURFACE

The monitor may cause an injury if it falls or is dropped.

DO NOT USE THE MONITOR NEAR WATER

Do not use where water may be splashed or spilt onto the monitor as it may cause fire or electric shock.

OPERATE UNDER THE SPECIFIED POWER SUPPLY

Be sure to operate the monitor only with the specified power supply. Use of an incorrect voltage will cause malfunction and may cause fire or electric shock.

PROTECT THE CABLES

Do not pull or bend the power cable and signal cable. Do not place the monitor or any other heavy objects on the cables. If damaged, the cables may cause fire or electric shock.

ADVERSE WEATHER CONDITIONS

It is advisable not to operate the monitor during a heavy thunder storm as the continual breaks in power may cause malfunction. It is also advised not to touch the plug in these circumstances as it may cause electric shock.

CAUTION

INSTALLATION LOCATION

Do not install the monitor where sudden temperature changes may occur, or in humid, dusty or smoky areas as it may cause fire, electric shock or damage. You should also avoid areas where the sun shines directly on the monitor.

DO NOT PLACE THE MONITOR IN A HAZARDOUS POSITION

The monitor may topple and cause injury if not suitably located. Please also ensure that you do not place any heavy objects on the monitor, and that all cables are routed such that children may not pull the cables and possibly cause injury.

MAINTAIN GOOD VENTILATION

Ventilation slots are provided to keep the monitor from overheating. Covering the slots may cause fire. To allow adequate air circulation, place the monitor at least 10cm (or 4 inches) from any walls. When removing the tilt stand, the ventilation slots on the back side of the monitor can be blocked. This may overheat the monitor and may cause fire or damage. Make sure to allow enough ventilation when removing the tilt stand. Operating the monitor on its back, side, upside down or on a carpet or any other soft material may also cause damage.

DISCONNECT THE CABLES WHEN YOU MOVE THE MONITOR

When you move the monitor, turn off the power switch, unplug the monitor and be sure the signal cable is disconnected. If you do not disconnect them, it may cause fire or electric shock.

UNPLUG THE MONITOR

If the monitor is not in use for a long period of time it is recommended that it is left unplugged to avoid accidents.

HOLD THE PLUG WHEN DISCONNECTING

To disconnect the power cable or signal cable, always pull it by the plug. Never pull on the cable itself as this may cause fire or electric shock.

DO NOT TOUCH THE PLUG WITH WET HANDS

Pulling or inserting the plug with wet hands may cause electric shock.

WHEN YOU INSTALL THE MONITOR ON YOUR COMPUTER

Be sure the computer is strong enough to hold the weight of the monitor, otherwise, you may damage your computer.

CAREFUL! PROTECT YOUR HANDS AND FINGERS

- Be careful not to hurt your fingers or hands when you change the height or the angle.
- Injury can occur if care is not taken to avoid finger contact with the displays base when adjusting the height. (Just for height adjustable model.)

REMARK FOR 24/7 USAGE

This product is not specifically designed for 24/7 usage in all environments.

REMARK FOR WALL MOUNTING

This product is not designed for digital signage (electronic signboard) applications such as wall mounting.

OTHERS

ERGONOMIC RECOMMENDATIONS

To eliminate eye fatigue, do not operate the monitor against a bright background or in a dark room. For optimal viewing comfort, the monitor should be just below eye level and 40-60cm (16-24 inches) away from your eyes. When using the monitor over a prolonged time, a ten minute break every hour is recommended as looking at the screen continuously can cause eye strain.

SPECIAL NOTES ON LCD MONITORS

The following symptoms are normal with LCD monitors and do not indicate a problem.

- NOTE**
- When you first turn on the LCD monitor, the picture may not fit in the display area because of the type of computer that is used. In this case, adjust the picture position to the correct position.
 - You may find slightly uneven brightness on the screen depending on the desktop pattern you use.
 - Due to the nature of the LCD screen, an afterimage of the previous screen may remain after switching the image, when the same image is displayed for hours. In this case, the screen can be recovered slowly by changing the image or turning off the Power Switch for some hours.

CUSTOMER SERVICE

- NOTE**
- If you have to return your unit for service and the original packaging has been discarded, please contact your dealer or iiyama service center for advice or replacement packaging.

CLEANING

- WARNING**
- If you drop any materials or liquids such as water into the monitor when cleaning, unplug the power cable immediately and contact your dealer or iiyama service center.

- CAUTION**
- For safety reasons, turn off the power switch and unplug the monitor before you clean it.

- NOTE**
- To protect the LCD panel, do not scratch or rub the screen with a hard object.
 - Never use any of the following strong solvents. These will damage the cabinet and the LCD screen.

Thinner	Spray-type cleaner
Benzene	Wax
Abrasive cleaner	Acid or Alkaline solvent

- Touching the cabinet with any product made from rubber or plastic for a long time may cause degeneration or loss of paint on the cabinet.

CABINET Stains can be removed with a cloth lightly moistened with a mild detergent solvent. Then wipe the cabinet with a soft dry cloth.

LCD Periodic cleaning with a soft dry cloth is recommended.

SCREEN Don't use tissue paper etc. because these will damage the LCD screen.

BEFORE YOU OPERATE THE MONITOR

FEATURES

- ◆ Supports Resolutions up to 1920 × 1200
- ◆ High Contrast 1000:1 (Typical), Adv. Contrast Function Available / Brightness 300cd/m² (Typical) / Quick Response Time 4ms (Gray to Gray)
- ◆ Supports AMD FreeSync™ technology (through DisplayPort-inputs)
- ◆ Flicker - Free
- ◆ Blue Light Reducer
- ◆ Digital Character Smoothing
- ◆ Automatic Set-up
- ◆ 2 × 2W Stereo Speakers
- ◆ Standby Feature
- ◆ Ergonomic Design TCO Certified
- ◆ VESA Mounting Standard (100mm×100mm) Compliant
- ◆ Keyhole for Security Lock

CHECKING THE CONTENTS OF THE PACKAGE

The following accessories are included in your package. Check to see if they are enclosed with the monitor. If anything is missing or damaged, please contact your local iiyama dealer or regional iiyama office.

- | | | |
|-----------------------------|----------------------------|------------------------------|
| ■ Power Cable* ¹ | ■ DisplayPort Cable | ■ USB Cable |
| ■ Stand-Base with a screw | ■ Stand-Neck* ² | ■ Cable Holder* ² |
| ■ Safety Guide | ■ Quick Start Guide | |

CAUTION

*¹ The rating of the Power Cable enclosed in 120V area is 10A/125V. If you are using a power supply higher than this rating, then a power cable with a rating of 10A/250V must be used. However, all guarantees and warranties are void for any problems or damage caused by a power cable not supplied by iiyama.

An approved power cable greater or equal to H05VVVF, 3G, 0.75mm² must be used.

*² Accessory for ProLite XU2595WSU

INSTALLATION

CAUTION

- Before installation, make sure the display arm or desk arm stand is strong enough to hold the necessary weight of the monitor and the mount.
- Panel angle adjustment range : 22° upward and 5° downward

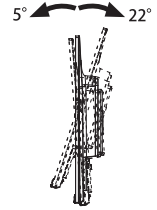

[DISPLAY ARM OR DESK ARM STAND]

CAUTION

- When you use with the display arm or desk arm stand, in consideration of thickness of the mounting stage, tighten the M4 Screws (4pcs) which "L" length is 7mm to fasten the monitor. Using the screw longer than this may cause electric shock or damage because it may contact with the electrical parts inside the monitor.

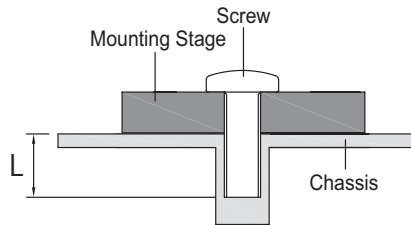

[ROTATING THE MONITOR]

• ProLite XUB2595WSU

The monitor is designed to be compatible with both landscape and portrait modes. Video card for portrait display will be required for rotating the image on the screen.

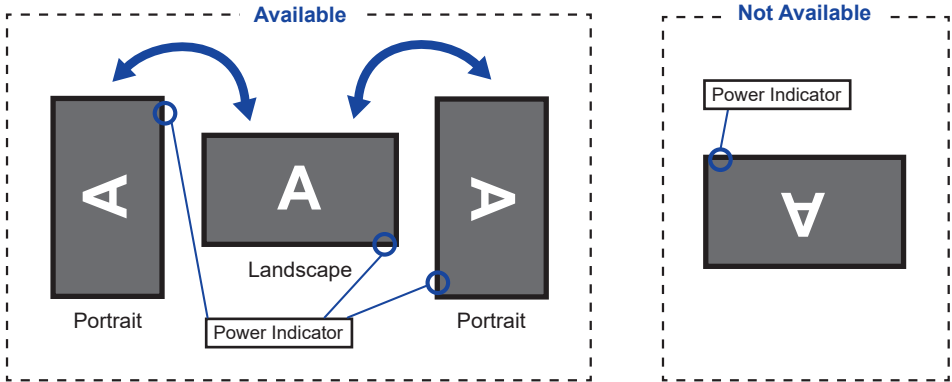

With Stand:

NOTE

- Adjust the monitor's height before panel rotation.
- Attempting to rotate the panel forcibly without adjusting the stand height may cause damage to the panel or the stand.

• ProLite XU2595WSU

The monitor is designed to be compatible only with the landscape mode.

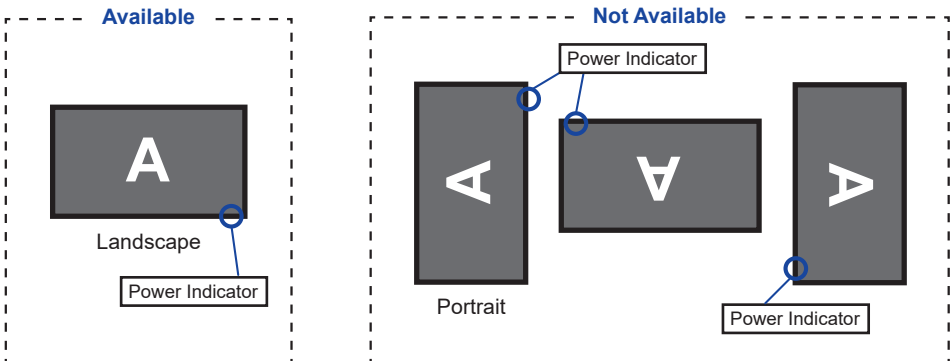

FITTING AND REMOVAL OF BASE : ProLite XUB2595WSU

CAUTION

- Put the monitor on a stable surface. The monitor may cause injury or damage if it falls or is dropped.
- Do not give a strong impact to the monitor. It may cause damage.
- Unplug the monitor before removal or installation to avoid an electric shock or a damage.

<Installation>

- ① Put a piece of soft cloth on the table beforehand to prevent the monitor from being scratched. Lay the monitor flat on a table with front face down.
- ② Install the Stand-Base so that it can fit the Hook of the Stand-Neck.
- ③ Use the 'thumb screw' provided to secure the Stand-Base to the monitor.

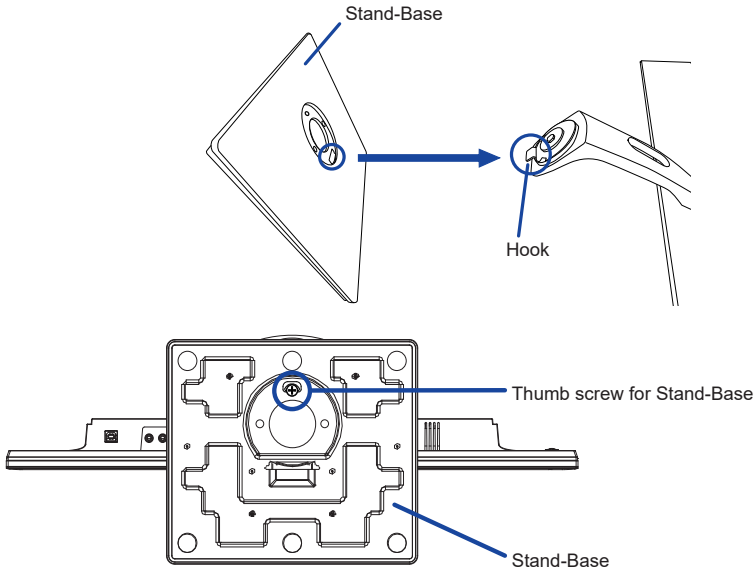

<Removal>

- ① Put a piece of soft cloth on the table beforehand to prevent the monitor from being scratched. Lay the monitor flat on a table with front face down.
- ② Loosen the 'thumb screw' to remove the Stand-Base from the monitor.

FITTING AND REMOVAL OF BASE : ProLite XU2595WSU

CAUTION

- Put the monitor on a stable surface. The monitor may cause injury or damage if it falls or is dropped.
- Do not give a strong impact to the monitor. It may cause damage.
- Unplug the monitor before removal or installation to avoid an electric shock or a damage.

<Installation>

- ① Put a piece of soft cloth on the table beforehand to prevent the monitor from being scratched. Lay the monitor flat on a table with front face down.
- ② Hold the monitor and install the Stand-Neck to the monitor until it clicks to secure.
- ③ Install the Stand-Base to the Stand-Neck.
- ④ Use the 'thumb screw' provided to secure the Stand-Base to the monitor.

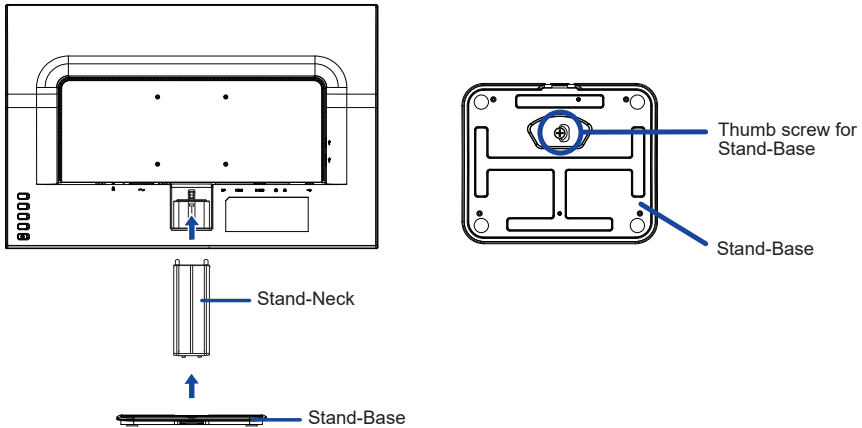

<Removal>

- ① Put a piece of soft cloth on the table beforehand to prevent the monitor from being scratched. Lay the monitor flat on a table with front face down.
- ② Loosen the 'thumb screw' to remove the Stand-Base from the monitor.
- ③ Press the Hook on the back of the monitor and remove the Stand-Neck from the monitor.

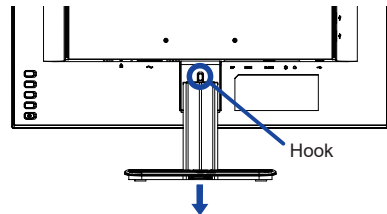

[Cable Holder]

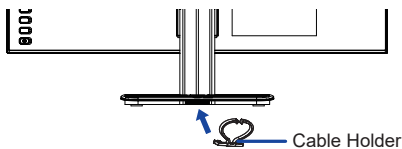

Place the Cable Holder.

CONTROLS AND CONNECTORS : ProLite XUB2595WSU

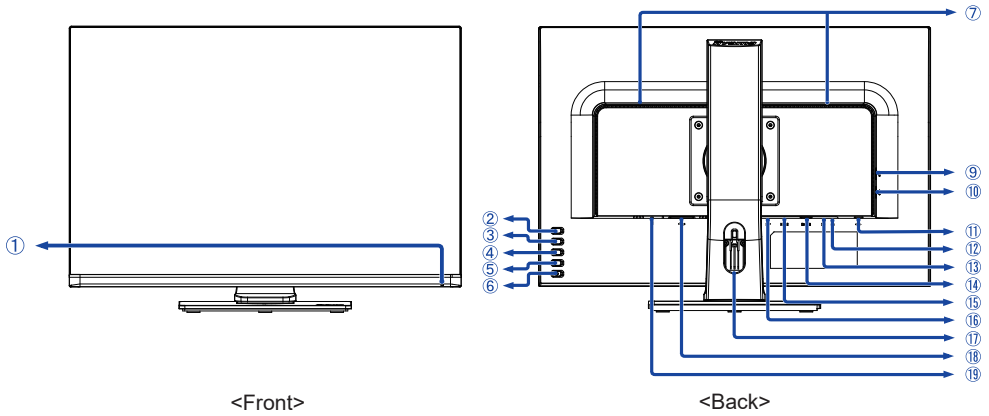

① Power Indicator

NOTE Blue: Normal operation
Orange: Standby mode

② Auto Adjust / Signal Select Button (AUTO)*

③ - / Eco Button (-)*

④ + / Volume / Blue Light Reducer Button (+)*

⑤ Menu Button (MENU)

⑥ Power Switch (⏻)

⑦ Speakers

⑨ USB Downstream Connector (5V, 500mA)

⑩ USB Downstream Connector (5V, 500mA)

⑪ USB Upstream Connector

⑫ Headphone connector

⑬ Audio Connector

⑭ VGA Connector (D-SUB)

⑮ HDMI Connector (HDMI)

⑯ DisplayPort Connector (DP)

⑰ Cable Hole

⑱ AC Connector (~ : Alternating current)

⑲ Keyhole for Security Lock

NOTE You can fasten a security lock and cable to prevent the monitor from being removed without your permission.

* You can skip the Menu items and directly display an option setting screen or an adjustment scale.

CONTROLS AND CONNECTORS : ProLite XU2595WSU

ENGLISH

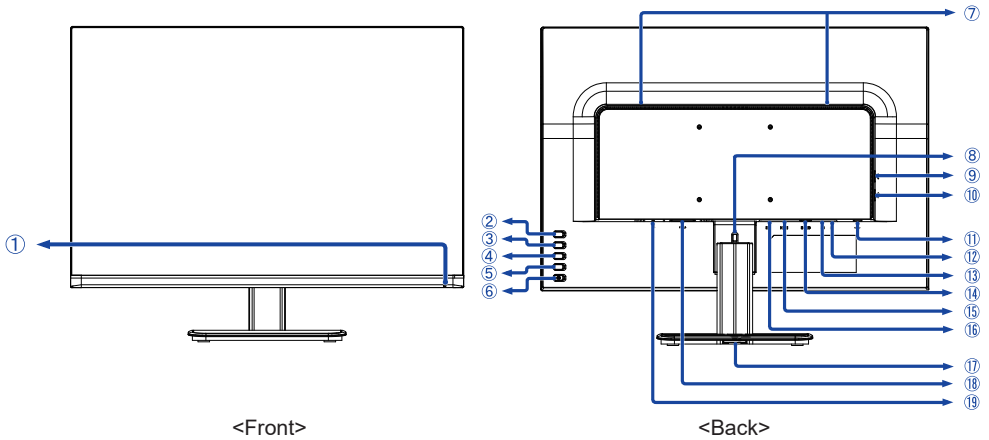

① Power Indicator

NOTE Blue: Normal operation
Orange: Standby mode

- ② Auto Adjust / Signal Select Button (AUTO)*
- ③ - / Eco Button (-)*
- ④ + / Volume / Blue Light Reducer Button (+)*
- ⑤ Menu Button (MENU)
- ⑥ Power Switch (⏻)
- ⑦ Speakers
- ⑧ Hook
- ⑨ USB Downstream Connector (↔ 5V, 500mA)
- ⑩ USB Downstream Connector (↔ 5V, 500mA)
- ⑪ USB Upstream Connector (↔)
- ⑫ Headphone connector (🎧)
- ⑬ Audio Connector (🔊)
- ⑭ VGA Connector (D-SUB)
- ⑮ HDMI Connector (HDMI)
- ⑯ DisplayPort Connector (DP)
- ⑰ Installation Hole of Cable Holder
- ⑱ AC Connector (~ : Alternating current)

⑰ Installation Hole of Cable Holder

NOTE You can fasten a security lock and cable to prevent the monitor from being removed without your permission.

* You can skip the Menu items and directly display an option setting screen or an adjustment scale.

CONNECTING YOUR MONITOR : ProLite XUB2595WSU

- ① Ensure that both the computer and the monitor are switched off.
- ② Connect the computer to the monitor with the signal cable.
- ③ Connect the computer to the monitor with the USB Cable.
- ④ Connect the monitor to the audio equipment with the Audio Cable for computer when using the audio features.
- ⑤ Connect the Power Cable to the monitor first and then to the power source.
- ⑥ Turn on your monitor and computer.

NOTE

- Make sure that the building installation has a circuit breaker of 120/240V, 20A (maximum).
- The signal cables used for connecting the computer and monitor may vary with the type of computer used. An incorrect connection may cause serious damage to both the monitor and the computer. The cable supplied with the monitor is for a standard connector. If a special cable is required please contact your local iiyama dealer or regional iiyama office.
- Make sure you tighten the finger screws at each end of the signal cable.
- The Class I pluggable equipment Type A must be connected to protective earth.
- The socket-outlet shall be installed near the equipment and shall be easily accessible.
- Excessive sound pressure from ear-/headphones can cause hearing damage/hearing loss.

[Example of Connection]

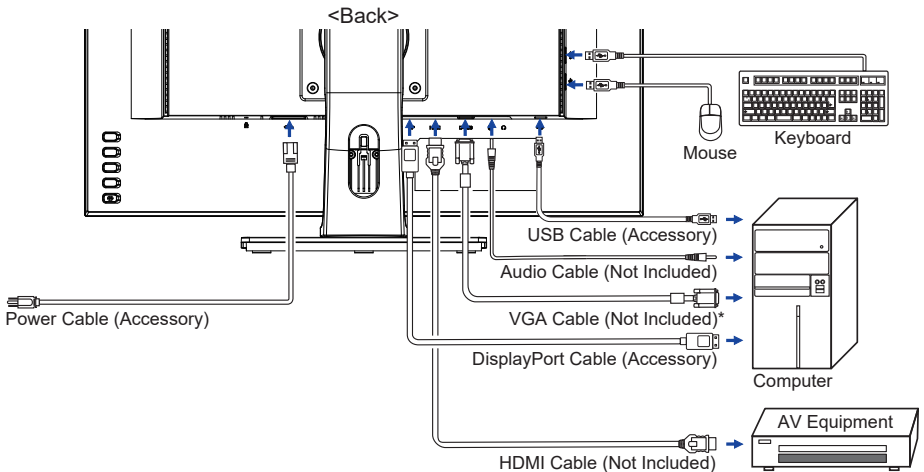

* VGA cable is not supplied with the monitor. If you use low quality VGA cable, it may cause a result of electro-magnetic interference. Please contact the iiyama Support Centre in your country if you wish to connect the monitor via the VGA input.

[Collect Cables]

Put the cables through the Cable Hole to bundle them.

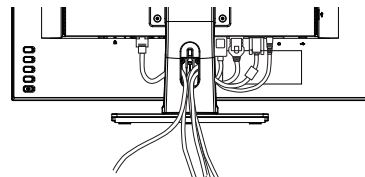

CONNECTING YOUR MONITOR : ProLite XU2595WSU

- ① Ensure that both the computer and the monitor are switched off.
- ② Connect the computer to the monitor with the signal cable.
- ③ Connect the computer to the monitor with the USB Cable.
- ④ Connect the monitor to the audio equipment with the Audio Cable for computer when using the audio features.
- ⑤ Connect the Power Cable to the monitor first and then to the power source.
- ⑥ Turn on your monitor and computer.

NOTE

- Make sure that the building installation has a circuit breaker of 120/240V, 20A (maximum).
- The signal cables used for connecting the computer and monitor may vary with the type of computer used. An incorrect connection may cause serious damage to both the monitor and the computer. The cable supplied with the monitor is for a standard connector. If a special cable is required please contact your local iiyama dealer or regional iiyama office.
- Make sure you tighten the finger screws at each end of the signal cable.
- The Class I pluggable equipment Type A must be connected to protective earth.
- The socket-outlet shall be installed near the equipment and shall be easily accessible.
- Excessive sound pressure from ear-/headphones can cause hearing damage/hearing loss.

[Example of Connection] <Back>

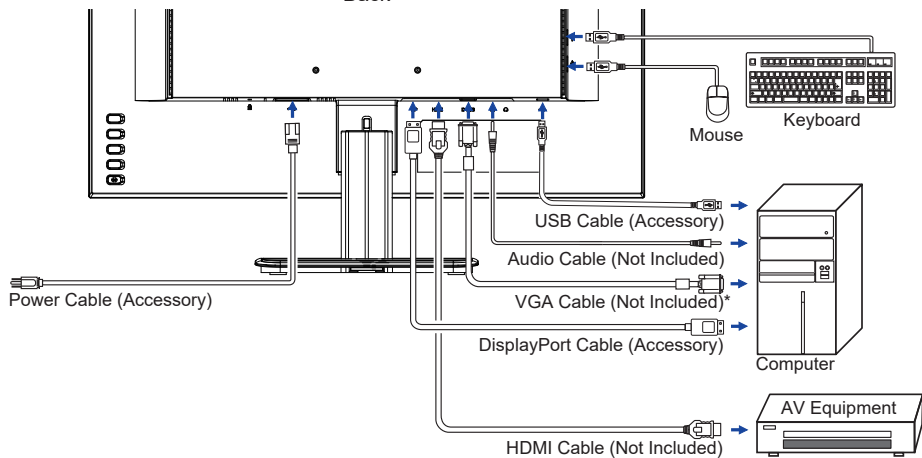

* VGA cable is not supplied with the monitor. If you use low quality VGA cable, it may cause a result of electro-magnetic interference. Please contact the iiyama Support Centre in your country if you wish to connect the monitor via the VGA input.

[Collect Cables]

Put the cables through the Cable Holder to bundle them.

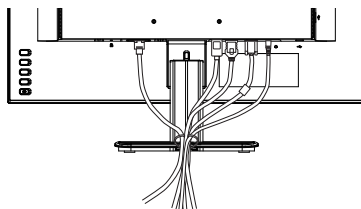

DISCONNECTING YOUR MONITOR

- ① Ensure that both the computer and the monitor are switched off.
- ② Disconnect the power source first and then the Power Cable from the monitor.
- ③ Disconnect the audio cable from the computer and the monitor.
- ④ Disconnect the USB cable from the computer and the monitor.
- ⑤ Disconnect the signal cable from the computer and the monitor.

COMPUTER SETTING

■ Signal Timing

Change to the desired signal timing listed on page 31: COMPLIANT TIMING.

ADJUSTING THE HEIGHT AND THE VIEWING ANGLE : ProLite XUB2595WSU

- For optimal viewing it is recommended to position yourself directly opposite to the full face of the monitor, then adjust the monitor's height and angle to your own preference.
- Hold the panel so that the monitor does not topple when you change the monitor's height or angle.
- You are able to adjust the monitor's height up to 130mm, angle up to 45° right and left, 22° upward and 5° downward.

NOTE

- Do not touch the LCD screen when you change the height or the angle. It may cause damage or break the LCD screen.
- Careful attention is required not to pinch your fingers or hands into the moving part of the stand when you change the height or the angle.
- Injury can occur if care is not taken to avoid finger contact with the displays base when adjusting the height.

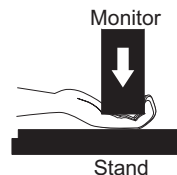
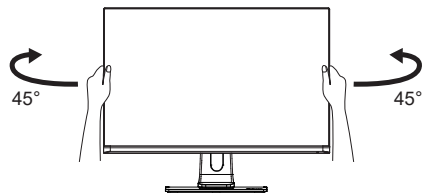
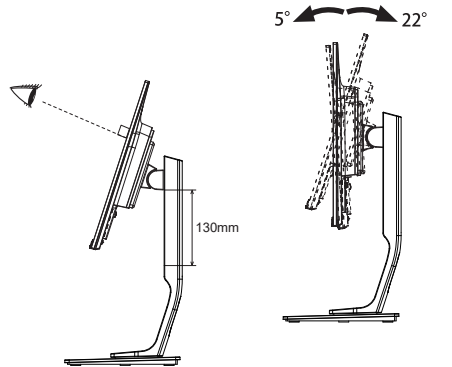

ADJUSTING THE VIEWING ANGLE : ProLite XU2595WSU

- For optimal viewing it is recommended to look at the full face of the monitor.
- Hold the stand so that the monitor does not topple when you change the monitor's angle.
- You are able to adjust the monitor's angle up to 20° upward, 4° downward.
- In order to ensure a healthy and relaxed body position when using the monitor at visual display workstations, it is recommended that the adjusted tilt angle should not exceed 10 degrees. Adjust the monitor's angle to your own preference.

- NOTE**
- Do not touch the LCD screen when you change the height or the angle. It may cause damage or break the LCD screen.
 - Careful attention is required not to pinch your fingers or hands into the moving part of the stand when you change the angle.

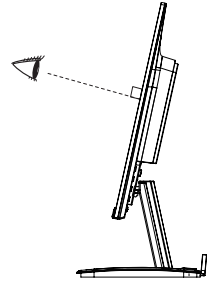
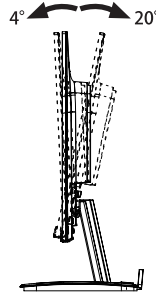

OPERATING THE MONITOR

To create the best picture, your iiyama LCD monitor has been preset at the factory with the COMPLIANT TIMING shown on page 31. You are also able to adjust the picture by following the button operation shown below. For more detailed adjustments, see page 22 for SCREEN ADJUSTMENTS.

- ① Press the MENU Button to start the On Screen Display feature. There are additional Menu items which can be switched by using the + / - Buttons.



- ② Select the Menu item which contains the adjustment icon relating to the adjustment you want to make. Press the MENU Button. Then, use the + / - Buttons to highlight the desired adjustment icon.
- ③ Press the MENU Button again. Use the + / - Buttons to make the appropriate adjustment or setting.
- ④ Press the AUTO Button to leave the menu, and the settings you just made would be automatically saved.

For example, to correct for vertical position, select Menu item of Image Settings and then press the MENU Button. Then, select Vertical Position by using the + / - Buttons.

An adjustment page appears after you press the MENU Button. Then, use the + / - Buttons to change the vertical position settings. The vertical position of the overall display should be changing accordingly while you are doing this.

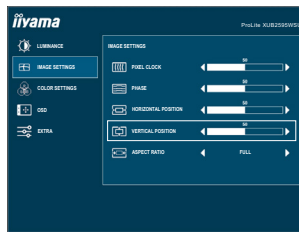









Press the AUTO Button lastly, it ends, all changes are saved in the memory.

NOTE

- When button operations are aborted during adjustment, On-Screen Display disappears when the time set for the OSD Timeout has passed. Also, the AUTO Button can be used to return previous menu and turn off the On-Screen Display.
- Any changes are automatically saved in the memory when the On Screen Display disappears. Turning off the power should be avoided while using the Menu.
- Adjustments for Horizontal / Vertical Position, Pixel Clock and Phase are saved for each signal timing. Except for these adjustments, all other adjustments have only one setting which applies to all signal timings.

ADJUSTMENT MENU CONTENTS

Adjustment Item		Problem / Option		Button to Press
Contrast		Too dull Too intense		   
Brightness* ¹		Too dark Too bright		   
i-Style Color* ²	Standard	For general windows environment and monitor default setting.		
	Text	For text editing and viewing in a word processing environment.		
	Internet	For internet environment.		
	Game	For PC game environment.		
	Movie	For movie and video environment.		
	Sports	For sport environment.		
Adv. Contrast* ²	On	Increased Contrast Ratio		
	Off	Typical Contrast Ratio		
<p>NOTE Adv. Contrast adjusts brightness according to the image, and improve the contrast ratio during movie playing. Contrast, Brightness, Gamma, Color Temp., Eco and i-Style Color cannot be adjusted and selected while Adv. Contrast is active.</p>				
Eco	Direct	Off	Normal	
		Mode1	Brightness of back-light is reduced.	
		Mode2	Brightness of back-light is reduced more than Mode1.	
		Mode3	Brightness of back-light is reduced more than Mode2.	

*¹ Adjust the Brightness when you are using the monitor in a dark room and feel the screen is too bright.

*² i-Style Color and Adv. Contrast are disabled when Blue Light Reducer is activated.

Direct









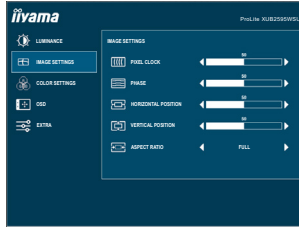













You can skip the Menu items and directly display an option setting screen by using the following button operations.

- Eco: Press the – Button when the Menu is not displayed.



Image Settings



Adjustment Item	Problem / Option	Button to Press
Pixel Clock* ^{1,2}	 Too narrow  Too wide	   
Phase* ^{1,2}	To correct flickering text or lines	   
Horizontal Position* ²	 Too left  Too right	   
Vertical Position* ²	 Too low  Too high	   
Aspect Ratio	Full	Expansion display
	Aspect	Expansion display of Aspect

*¹ See page 22 for SCREEN ADJUSTMENTS.

*² Only for Analog Input.



Color Settings

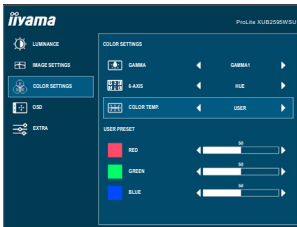

Adjustment Item	Problem / Option		Button to Press	
Gamma	Gamma1	Normal		
	Gamma2	High contrast		
	Gamma3	Dark		
6-Axis	Hue	Red	Too weak Too strong	+ -
		Yellow		
		Green		
		Cyan		
		Blue		
		Magenta		
	Saturation	Red	Too weak Too strong	+ -
		Yellow		
		Green		
		Cyan		
	Blue			
	Magenta			
Color Temp.	Warm			
	Normal			
	Cool			
	User	Red	Too weak Too strong	+ -
		Green		
Blue				
sRGB *				







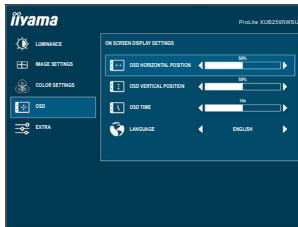

NOTE

- sRGB is an international standard which defines and unifies the difference of color appearance between equipment.
- You can not adjust the Contrast, Brightness, i-Style Color, Adv. Contrast, Gamma, Blue Light Reducer and Eco during sRGB mode because those settings are locked.

* sRGB adjustments is disabled when Blue Light Reducer is activated.

OSD



Adjustment Item	Problem / Option		Button to Press	
OSD Horizontal Position	OSD is too left OSD is too right			 
OSD Vertical Position	OSD is too low OSD is too high			 
OSD Time	You can set the OSD display duration time between 5 and 100 seconds.			 
Language	English	English	Polski	Polish
	Français	French	Русский	Russian
	Deutsch	German	日本語	Japanese
	Nederlands	Dutch		

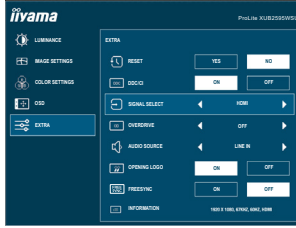

Adjustment Item	Problem / Option		Button to Press
Reset	Yes	Factory-preset data is restored.	
	No	Return to Menu.	
DDC/CI	On	DDC/CI is On.	
	Off	DDC/CI is Off.	
Signal Select Direct	Auto	Select the signal input automatically.	
	D-SUB	Select the Analog input.	
	HDMI	Select the Digital (HDMI) input.	
	DP	Select the Digital (DisplayPort) input.	
<p>NOTE</p> <p>At selected the AUTO, it will automatically be selected when just one source is available. If there are more input sources available and you select one of them, the AUTO option is not available. If multiple inputs are connected, the monitor may not recover the last one used after turning it off and on again. It is only possible when you set a specific source.</p>			
OverDrive*1	Off / -2 / -1 / 0 / +1 / +2 It will improve the gray level response time of the LCD panel. A higher level results in a faster response time.		
Audio Source*2	HDMI	Select the HDMI input.	
	DP	Select the DisplayPort input.	
	LINE IN	Select the LINE IN input.	
Opening Logo	On	Opening Logo is On.	
	Off	Opening Logo is Off.	
FreeSync*3	On	Enable the Freesync function.	
	Off	The Freesync function is turned off.	
Information	Displays information regarding the current input signal coming from the graphic card in your computer. NOTE See your graphic card user guide for more information about changing the resolution and refresh.		

*1 When OverDrive is activated, some level of image retention will be caused.

*2 Suitable for HDMI/DisplayPort input only.

*3 Only for DisplayPort input.

Direct

You can skip the Menu items and directly display an option setting screen by using the following button operations.



- Signal Select: Press the AUTO Button when the Menu is not displayed, it shows following Menu. Press the AUTO Button again to select input source and then press the MENU Button.



Direct

You can skip the Menu items and directly display an option setting screen or an adjustment scale by using the following button operations.

- Volume: Press the + Button when the Menu is not displayed.

Adjustment Item	Problem / Option	Button to Press
Volume	Too soft Too loud	 <input type="button" value="+"/>  <input type="button" value="-"/>

- Auto Adjust: Keep pressing the AUTO Button for 3-4 seconds when the Menu is not displayed.

Only Analog Input

Adjustment Item	Problem / Option
Auto Adjust *	Adjust Horizontal / Vertical Position, Pixel Clock and Phase automatically.

* For best results, use the Auto Adjust in conjunction with the adjustment pattern. See page 22 for SCREEN ADJUSTMENTS.

- Blue Light Reducer * : Keep pressing the + Button for 3-4 seconds when the Menu is not displayed.
Off : Normal
Mode1 : Blue light is reduced.
Mode2 : Blue light is reduced more than Mode1.
Mode3 : Blue light is reduced more than Mode2.

* Blue Light Reducer cannot be enabled if i-Style Color, Adv.Contrast or sRGB color are enabled.

- Lock Mode:

<OSD>

Hold the MENU Button and turn on the monitor when the monitor is powered-off, it will lock/unlock the OSD function.

<Power/OSD>

Keep pressing the MENU button for 10 seconds when Menu is not displayed, it will lock/unlock the Power Switch and OSD function.

SCREEN ADJUSTMENTS

Adjust the image by following the procedure below to get the desired picture when selecting Analog input.

- The screen adjustments described in this manual are designed to set image position and minimize flicker or blur for the particular computer in use.
- The monitor is designed to provide the best performance at resolution of 1920 × 1200, but can not provide the best at resolutions of less than 1920 × 1200 because the picture is automatically stretched to fit the full screen. It is recommended to operate at resolution of 1920 × 1200 in normal use.
- Displayed text or lines will be blurred or irregular in thickness when the picture is stretched due to the screen enlargement process.
- It is preferable to adjust the image position and frequency with the monitor controls, rather than the computer software or utilities.
- Perform adjustments after a warm-up period of at least thirty minutes.
- Additional adjustments may be required after the Auto Image Adjust depending on the resolution or signal timing.
- The Auto Image Adjust may not work correctly when displaying the picture other than the screen adjustment pattern. In this case, manual adjustments are required.

There are two ways to adjust the screen. One way is automatic adjustment for Position, Pixel Clock and Phase. The other way is performing each adjustment manually.

Perform the Auto Adjust first when the monitor is connected to a new computer, or resolution is changed. If the screen has a flicker or blur, or the picture does not fit in the display area after performing the Auto Adjust, manual adjustments are required. Both adjustments should be made by using the screen adjustment pattern (Test.bmp) obtained via the Iiyama web site (<http://www.iiyama.com>).

Adjust the image by following the procedure below to get the desired picture.

This manual explains adjustment under Windows® OS.

- ① **Display the picture at the optimum resolution.**
- ② **Enter the Test.bmp (screen adjustment pattern) to wallpaper.**

NOTE

- Consult the appropriate documentation for doing this.
- Set the display position to center in the wallpaper setting dialogue box.

[Adjustment pattern]

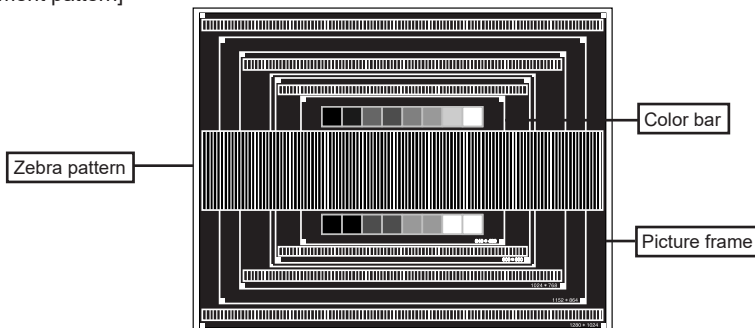

- ③ Keep pressing the AUTO Button for about 3-4 seconds. (Auto Adjust)
- ④ Adjust the image manually by following procedure below when the screen has a flicker or blur, or the picture does not fit in the display area after performing the Auto Adjust.
- ⑤ Adjust the Vertical Position so that the top and bottom of the picture frame will fit to the display area.

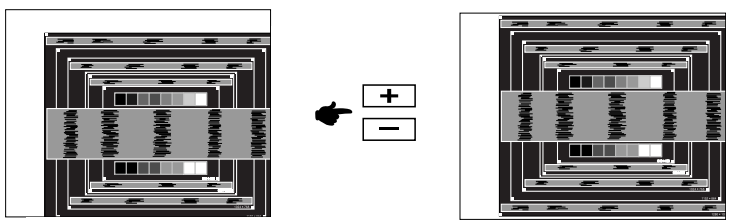

- ⑥ 1) Adjust the Horizontal Position so that the left side of the picture frame will move to the left edge of the display area.

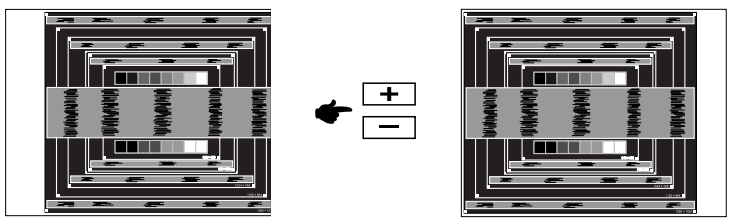

- 2) Stretch the right side of the picture frame to the right edge of the display area by adjusting the Pixel Clock.

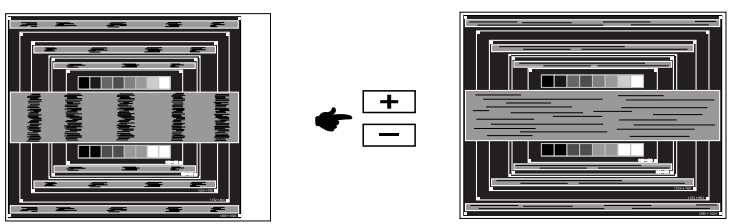

NOTE

- When the left side of the picture frame moves apart from the left edge of the display area during the Pixel Clock adjustment, adjust steps 1) and 2).
- Another way to make the Pixel Clock adjustment is to correct the vertical wavy lines in the zebra pattern.
- The picture may flicker during the Pixel Clock, Horizontal Position and Vertical Position adjustment.
- In case the picture frame is bigger or smaller than the data display area after the Pixel Clock adjustment, repeat steps from ③.

⑦ **Adjust the Phase to correct horizontal wavy noise, flicker or blur in the zebra pattern.**

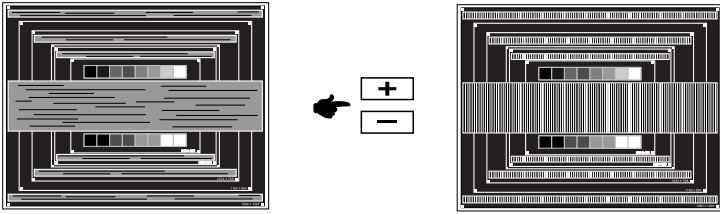

NOTE

- In case the strong flicker or blurs remain on a part of the screen, repeat steps ⑥ and ⑦ because the Pixel Clock may not be adjusted correctly. If the flicker or blurs still remain, set the refresh rate of computer to low (60Hz) and repeat steps from ③ again.
- Adjust the Horizontal Position after the Phase adjustment if the horizontal position moves during the adjustment.

⑧ **Adjust the Brightness and Color to get the desired picture after you complete the Pixel Clock and Phase adjustments.**

Put back your favorite wallpaper.

STANDBY FEATURE

This product features the standby function. When activated, it automatically reduces unnecessary power consumption of the monitor when your computer is not in use.

There is a standby step the monitor takes as described below. The standby function, including any timer settings is configured by the operating system. Check your operating system manual for information on how this can be configured.

■ Standby Mode

When the video signal from the computer is off, the monitor enters into Standby Mode which reduces the power consumption to less than 0.5W*. The screen becomes dark, and the power indicator turns to orange. From Standby Mode, the image reappears in several seconds when either the keyboard or the mouse are touched again.

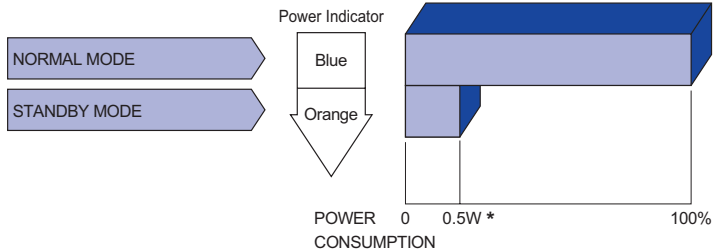

* When the USB devices are not connected.

TROUBLE SHOOTING

If the monitor fails to operate correctly, please follow the steps below for a possible solution.

1. Perform the adjustments described in OPERATING THE MONITOR, depending on the problem you have. If the monitor does not get a picture, skip to 2.
2. Consult the following items if you cannot find an appropriate adjustment item in OPERATING THE MONITOR or if the problem persists.
3. If you are experiencing a problem which is not described below or you cannot correct the problem, discontinue using the monitor and contact your dealer or iiyama service center for further assistance.

Problem

Check

- | | |
|--|---|
| <p>① The picture does not appear.
(Power indicator does not light up.)

(Power indicator is blue.)

(Power indicator is orange.)</p> | <p><input type="checkbox"/> The Power Cable is firmly seated in the socket.
<input type="checkbox"/> The Power Switch is turned ON.
<input type="checkbox"/> The AC socket is live. Please check with another piece of equipment.</p> <p><input type="checkbox"/> If the blank screen saver is in active mode, touch the keyboard or the mouse.
<input type="checkbox"/> Increase the Contrast and/or Brightness.
<input type="checkbox"/> The computer is ON.
<input type="checkbox"/> The Signal Cable is properly connected.
<input type="checkbox"/> The signal timing of the computer is within the specification of the monitor.</p> <p><input type="checkbox"/> If the monitor is in standby mode, touch the keyboard or the mouse.
<input type="checkbox"/> The computer is ON.
<input type="checkbox"/> The Signal Cable is properly connected.
<input type="checkbox"/> The signal timing of the computer is within the specification of the monitor.</p> |
| <p>② The screen is not synchronized.</p> | <p><input type="checkbox"/> The Signal Cable is properly connected.
<input type="checkbox"/> The signal timing of the computer is within the specification of the monitor.</p> |
| <p>③ The screen position is not in the center.</p> | <p><input type="checkbox"/> The signal timing of the computer is within the specification of the monitor.</p> |
| <p>④ The screen is too bright or too dark.</p> | <p><input type="checkbox"/> The video output level of the computer is within the specification of the monitor.</p> |
| <p>⑤ The screen is shaking.</p> | <p><input type="checkbox"/> The power voltage is within the specification of the monitor.
<input type="checkbox"/> The signal timing of the computer is within the specification of the monitor.</p> |

Problem

Check

- | | |
|--|---|
| <p>⑥ No sound.</p> <p>⑦ The sound is too loud or too quiet.</p> <p>⑧ A strange noise is heard.</p> | <p><input type="checkbox"/> The audio equipment (computer etc.) is ON.</p> <p><input type="checkbox"/> The Audio Cable is properly connected.</p> <p><input type="checkbox"/> The Volume is turned up.</p> <p><input type="checkbox"/> The audio output level of the audio equipment is within the specification of the monitor.</p> <p><input type="checkbox"/> The audio output level of the audio equipment is within the specification of the monitor.</p> <p><input type="checkbox"/> The Audio Cable is properly connected.</p> |
|--|---|

RECYCLING INFORMATION

For better environment protection please don't dispose your monitor.
Please visit our web site: www.iiyama.com for monitor recycling.

APPENDIX

Design and specifications are subject to change without prior notice.

SPECIFICATIONS : ProLite XUB2595WSU

ENGLISH

Size Category	25"	
LCD Panel	Panel technology	IPS
	Size	Diagonal: 24.95" (63.36cm)
	Pixel pitch	0.27888mm H × 0.2823mm V
	Brightness	300cd/m ² (Typical)
	Contrast ratio	1000 : 1 (Typical), Adv. Contrast Function Available
	Viewable angle	Right / Left / Up / Down: 89 degrees each (Typical)
	Response time	4ms (Gray to Gray)
Display Colors	Approx.16.7M	
Sync Frequency	Analog: Horizontal: 30.0-89.0kHz, Vertical: 50-75Hz Digital(HDMI): Horizontal: 30.0-85.0kHz, Vertical: 50-75Hz Digital(DisplayPort): Horizontal: 30.0-85.0kHz, Vertical: 48-75Hz	
Native Resolution	1920 × 1200, 2.3 MegaPixels	
Supported max. resolution	VGA : 1920 × 1200, 60Hz HDMI : 1920 × 1200, 60Hz DisplayPort : 1920 × 1200, 75Hz	
Input Connector	VGA, HDMI, DisplayPort	
Input Sync Signal	Separate sync: TTL, Positive or Negative	
Input Video Signal	Analog: 0.7Vp-p (Standard), 75Ω, Positive Digital: HDMI, DisplayPort	
USB Standard	USB2.0	
Number of USB Ports	1 Upstream : Series B	
Connector shape	2 Downstream : Series A	
Input Audio Connector	ø 3.5mm mini jack (Stereo)	
Input Audio Signal	1.0Vrms maximum	
Headphone Connector	ø 3.5mm mini jack (Stereo)	
Speakers	2W × 2 (Stereo speakers)	
Maximum Screen Size	535.4mm W × 338.7mm H / 21.1" W × 13.3" H	
Power Source	100-240VAC, 50/60Hz, 1.5A	
Power Consumption *	28W typical, Standby mode: 0.5W maximum	
Dimensions / Net Weight	546.5 × 399.0 - 529.0 × 210.0mm / 21.5 × 15.7 - 20.8 × 8.3" (W×H×D) 5.2kg / 11.5lbs	
Angle	Tilt: Upward: 22 degrees, Downward: 5 degrees Swivel: Left / Right: 45 degrees each Rotation: Clockwise / Counterclockwise: 90 degrees each	
Environmental Considerations	Operating: Temperature 5 to 35°C / 41 to 95°F Humidity 10 to 80% (No condensation) Storage: Temperature -20 to 60°C / -4 to 140°F Humidity 5 to 85% (No condensation)	
Approvals	TCO Certified, CE, UKCA, TÜV-Bauart, EAC	

NOTE * When the USB devices are not connected.

SPECIFICATIONS : ProLite XU2595WSU

Size Category		25"
LCD Panel	Panel technology	IPS
	Size	Diagonal: 24.95" (63.36cm)
	Pixel pitch	0.27888mm H × 0.2823mm V
	Brightness	300cd/m ² (Typical)
	Contrast ratio	1000 : 1 (Typical), Adv. Contrast Function Available
	Viewable angle	Right / Left / Up / Down: 89 degrees each (Typical)
	Response time	4ms (Gray to Gray)
Display Colors		Approx.16.7M
Sync Frequency		Analog: Horizontal: 30.0-89.0kHz, Vertical: 50-75Hz Digital(HDMI): Horizontal: 30.0-85.0kHz, Vertical: 50-75Hz Digital(DisplayPort): Horizontal: 30.0-85.0kHz, Vertical: 48-75Hz
Native Resolution		1920 × 1200, 2.3 MegaPixels
Supported max. resolution		VGA : 1920 × 1200, 60Hz HDMI : 1920 × 1200, 60Hz DisplayPort : 1920 × 1200, 75Hz
Input Connector		VGA, HDMI, DisplayPort
Input Sync Signal		Separate sync: TTL, Positive or Negative
Input Video Signal		Analog: 0.7Vp-p (Standard), 75Ω, Positive Digital: HDMI, DisplayPort
USB Standard		USB2.0
Number of USB Ports Connector shape		1 Upstream : Series B 2 Downstream : Series A
Input Audio Connector		ø 3.5mm mini jack (Stereo)
Input Audio Signal		1.0Vrms maximum
Headphone Connector		ø 3.5mm mini jack (Stereo)
Speakers		2W × 2 (Stereo speakers)
Maximum Screen Size		535.4mm W × 338.7mm H / 21.1" W × 13.3" H
Power Source		100-240VAC, 50/60Hz, 1.5A
Power Consumption *		28W typical, Standby mode: 0.5W maximum
Dimensions / Net Weight		546.5 × 438.5 × 180.0mm / 21.5 × 17.3 × 7.1" (W×H×D) 3.9kg / 8.6lbs
Tilt Angle		Upward: 20 degrees, Downward: 4 degrees
Environmental Considerations		Operating: Temperature 5 to 35°C / 41 to 95°F Humidity 10 to 80% (No condensation) Storage: Temperature -20 to 60°C / -4 to 140°F Humidity 5 to 85% (No condensation)
Approvals		TCO Certified, CE, UKCA, TÜV-Bauart, EAC

NOTE * When the USB devices are not connected.

DIMENSIONS : ProLite XUB2595WSU

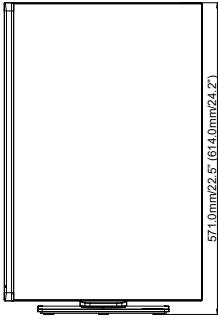
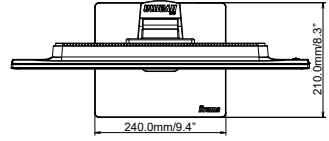
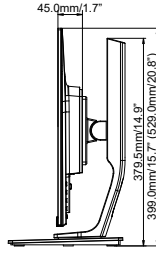
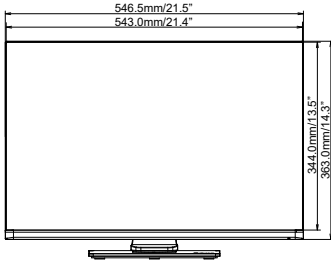

() : Maximum adjustment range

DIMENSIONS : ProLite XU2595WSU

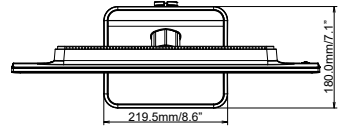
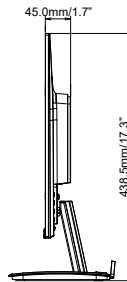
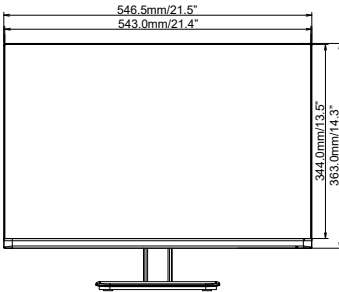

COMPLIANT TIMING

Video Mode	Horizontal Frequency	Vertical Frequency	Dot Clock
640 × 480	31.469kHz	59.940Hz	25.175MHz
	37.500kHz	75.000Hz	31.500MHz
	37.861kHz	72.809Hz	31.500MHz
800 × 600	35.156kHz	56.250Hz	36.000MHz
	37.879kHz	60.317Hz	40.000MHz
	46.875kHz	75.000Hz	49.500MHz
	48.077kHz	72.188Hz	50.000MHz
1024 × 768	48.363kHz	60.004Hz	65.000MHz
	56.476kHz	70.069Hz	75.000MHz
	60.023kHz	75.029Hz	78.750MHz
1280 × 1024	63.981kHz	60.020Hz	108.000MHz
	79.976kHz	75.025Hz	135.000MHz
1440 × 900	55.935kHz	59.887Hz	106.500MHz
1680 × 1050	65.290kHz	60.000Hz	146.250MHz
1920 × 1080	66.590kHz	59.930Hz	138.500MHz
1920 × 1200	74.038kHz	59.950Hz	154.000MHz
	93.149kHz	74.940Hz	193.750MHz

NOTE * DisplayPort input only.