

Floor supported wall lift for large format (Touch) displays from 65" up to 86"

Thanks to its double columns, this improved floor lift offers extra stability and robustness for working with touch displays from 65" up to 86 inch, 120kg. The display can easily be adjusted in height with the remote control and the electrical height adjustment is very silent. At the back side of the mounting utility there is space reserved to place a mini PC or thin client.

01 TECHNICAL SPECIFICATION

Type	Wall lift
Number of screens	1
Screen size	65" - 86"
Height adjustment	870mm, 936 - 1806mm
Max weight capacity	120kg / monitor
VESA maximum	800 x 600mm
Extra	electrical speed up to 38mm/s

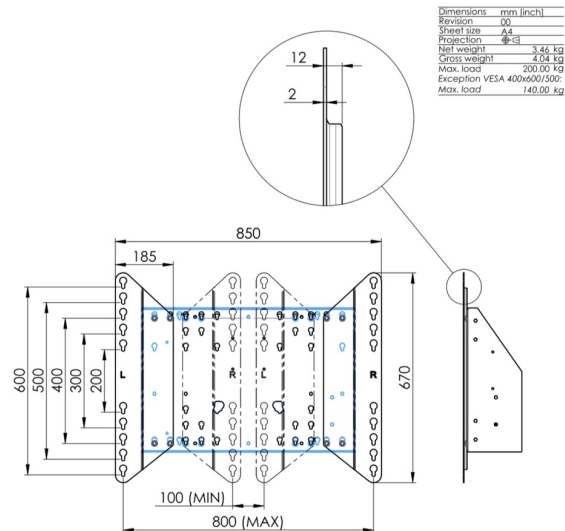
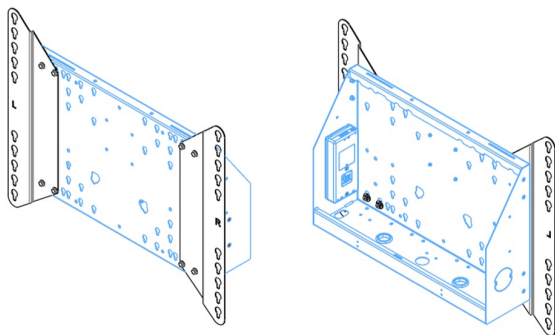
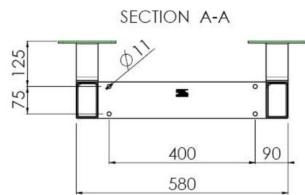
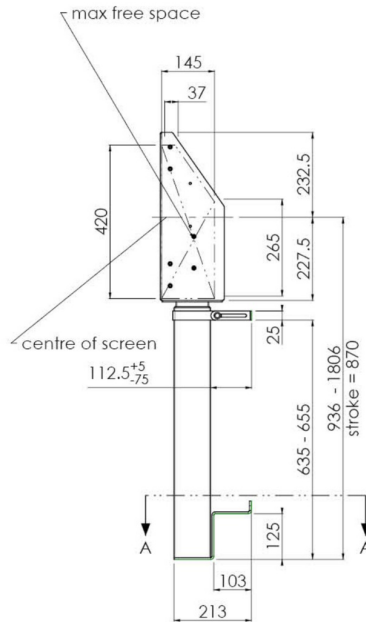
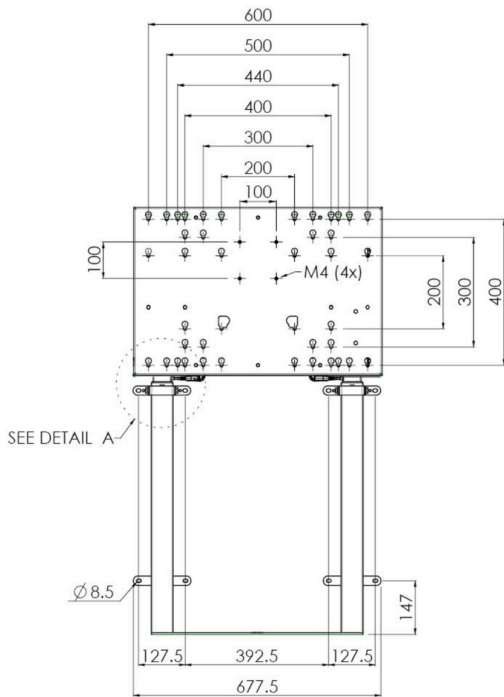
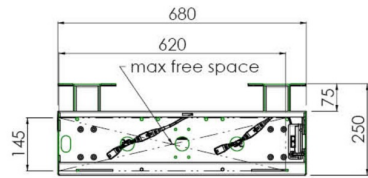

Dimensions	mm (inch)
Revision	00
Sheet size	A4
Projection	1st
Net weight	3.46 kg
Gross weight	4.34 kg
Max. load	200.00 kg
Exception VESA	400x500/500
Max. load	140.00 kg

02 DIMENSIONS / WEIGHT

Weight (without box)

36kg

EAN code

4948570032617

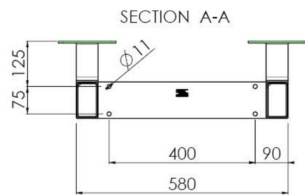
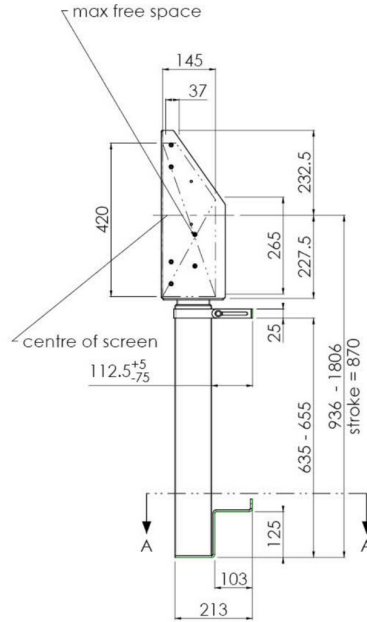
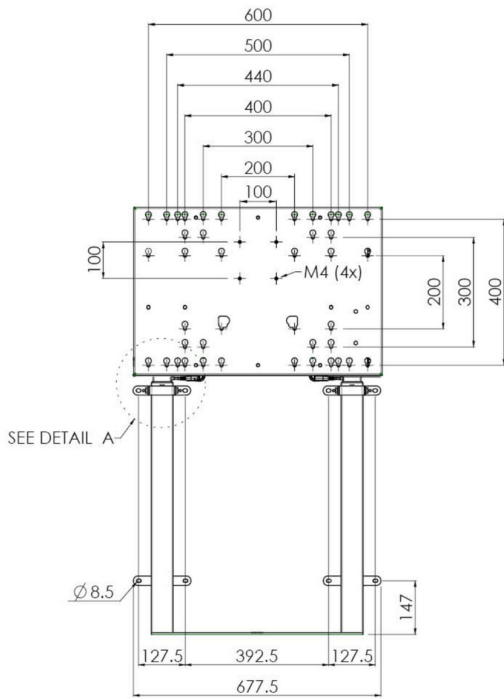
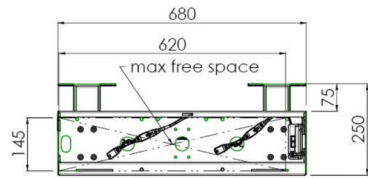

Dimensions	mm (inch)
Revision	00
Sheet size	A4
Projection	1E-3
Net weight	3.46 kg
Gross weight	4.34 kg
Max. load	200.00 kg
Exception VESA	400x600/500
Max. load	140.00 kg

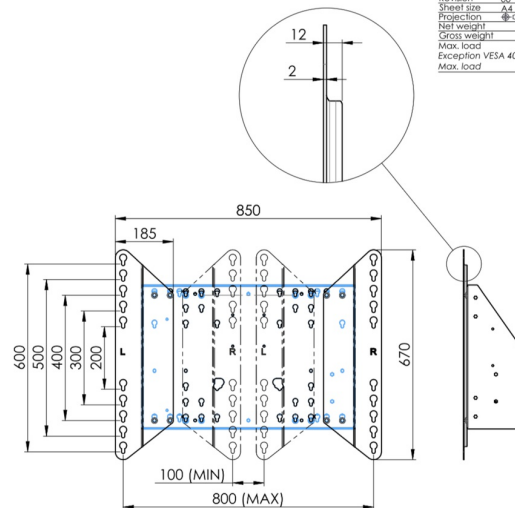
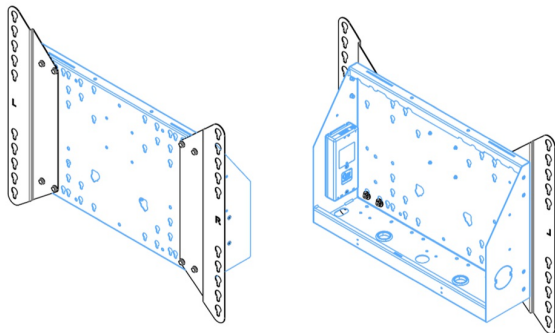

All trademarks and registered trademarks acknowledged. E & O E. Specification subject to change without notice. All LCD's comply with ISO-9241-307:2008 in connection with pixel defects.